

Nous vous remercions d'avoir choisi notre produit

Veillez lire attentivement cette carte de garantie et les instructions jointes avant de commencer tout travail.

Conservez les pendant toute la durée de vie du produit.

Les informations contenues dans la carte de garantie et les instructions sont actuels au moment de sa création. Les illustrations, photos et couleurs fournies sont uniquement destinées à faciliter le montage et ne sont en aucun cas contractuelles.

La société se réserve le droit d'apporter des modifications partielles ou complètes à tout moment sans notification préalable aux clients.

Le produit est destiné à l'usage privé, à l'exclusion de l'utilisation du logement ou d'activité commerciale. C'est un produit typiquement prévu pour le jardin privé.

Les chalets peuvent être utilisés pour stocker tous matériaux résistants à l'humidité, des meubles de jardin ou des outils de jardin.

STOCKAGE DES COMPOSANTS :

1. Il est recommandé de ne pas déballer le colis si le produit ne sera pas assemblé avant 72 heures.
2. En cas de températures extrêmes, supérieures à 25 ° C, le montage avant 24heures après ouverture est strictement recommandé.



3. À chaque cas où le colis doit être déballé, les éléments doivent être stockés à plat sur une surface plate, sous auvent et dans un endroit bien aéré, de manière à ce qu'ils ne soient pas voilés et qu'ils soient bien protégés des conditions atmosphériques sans avoir du contact avec le sol (ne pas les stocker dans une pièce chauffée).
4. Il est recommandé d'alourdir les éléments déballés sur toute leur longueur.
5. Au cas où le produit est stocké à l'extérieur, laissez un film de protection.
6. L'emballage du produit doit être éliminé conformément à la réglementation en vigueur.
7. Ne jamais utiliser l'emballage comme jouet. Les enfants ne peuvent pas avoir l'accès à l'emballage car il existe un risque d'accident comme exemple le glissement sur le film de protection, l'étranglement, l'avalement des petits éléments, etc.
8. Si, pour une raison quelconque, le montage devrait être interrompu, le produit et tous ses éléments non montés devraient être protégés contre les intempéries. Sinon, le fabricant ne sera pas responsable des dommages éventuels.
9. Il est recommandé de pré-percer les trous en utilisant une foreuse d'un diamètre inférieur à celui du vis de 1 Ø dans les endroits où le montage est prévu pour les vis.



AVANT L'INSTALLATION :

1. Vérifiez bien que le colis contient tous les éléments nécessaires conformément à la liste des éléments.
2. En cas de divergences, manques ou défauts, veuillez contacter le vendeur avant de commencer le montage, au plus tard dans 14 jours à partir de la date de livraison.
3. Pour déposer une plainte, indiquez sur la liste ci-jointe le nombre d'éléments manquants ou défectueux, en majuscules lisibles, et adressez-la au vendeur en précisant :
 - coordonnées de l'acheteur + une preuve d'achat
 - description des défauts + leurs photos (au moins une photo de chaque élément annoncé)
 - numéro et quantité d'éléments manquants
 - numéro de colis (un numéro unique mis sur l'étiquette - exemple ci-dessous)

IMPORTANT !

En l'absence des informations ci-dessus, la réclamation ne sera pas traitée de manière positive.

4. Si vous achetez directement dans le boutique Altanka, ou par une plate-forme de vente, les données ci-dessus doivent être introduites dans notre panel après-vente, disponible à l'adresse suivante : <https://sav.altanka.com.pl>



COMMENT TROUVER LE NO DE COLIS



Les documents sont mis juste au dessous de l'emballage, sur la structure bois.



Cette étiquette est collée sur la palette (le no de colis est doublé).

2,5x3,5 45mm

Classe	Longueur	Largeur	Épaisseur	Volume
1	40	35	45	0,63
2	40	35	45	0,63
3	40	35	45	0,63
4	40	35	45	0,63
5	40	35	45	0,63
6	40	35	45	0,63
7	40	35	45	0,63
8	40	35	45	0,63
9	40	35	45	0,63
10	40	35	45	0,63
11	40	35	45	0,63
12	40	35	45	0,63
13	40	35	45	0,63
14	40	35	45	0,63
15	40	35	45	0,63
16	40	35	45	0,63
17	40	35	45	0,63
18	40	35	45	0,63
19	40	35	45	0,63
20	40	35	45	0,63
21	40	35	45	0,63
22	40	35	45	0,63
23	40	35	45	0,63
24	40	35	45	0,63
25	40	35	45	0,63
26	40	35	45	0,63



No colis



Le même no de colis est mis sur les documents mis juste au dessous de l'emballage, sur la liste structure bois.

5. Choisissez avec soin l'endroit où le produit sera posé.

IMPORTANT !

Le produit ne doit pas être installé sous des lignes électriques, sur des installations au sol telles que l'électricité, l'eau, le gaz, là où un accès soit important ainsi que dans les endroits où une telle charge n'est pas prévue.

Le produit doit être installé dans un endroit où le contact avec de l'eau (y compris un système d'arrosage) n'aura pas lieu de manière continue.

L'installation doit être effectuée sur un sol plat et durci. Les éléments en bois ne doivent pas être en contact direct avec le sol (utilisez des éléments isolants, par exemple un feutre bitumé + lambourdes - achetez-les vous-même, si votre modèle ne les a pas dans l'ensemble).

6. Vérifiez auprès de votre mairie quels réglementations en vigueur s'appliquent au produit que vous avez acheté.
7. Effectuez les travaux de maçonnerie conformément aux instructions contenues dans ce manuel. Rappelez-vous que la préparation de la fondation doit être effectuée conformément aux pratiques de construction (prévoyez le temps nécessaire pour laisser sécher le béton!)
8. La dalle de béton doit avoir une épaisseur minimale de 10 cm. La dalle doit être toujours adaptée au terrain.
9. Les dimensions de la dalle de béton doivent correspondre à celles du produit (voir le plan dans l'instruction ci-jointe)
10. Assurez-vous que la fondation est parfaitement isolée, stable et nivelée.
11. Achetez la quantité indispensable du produit de traitement (voir notice - concerne les produits non traités) et couvrez tous les éléments en bois, à l'intérieur et à l'extérieur, conformément aux recommandations du fabricant du produit de traitement. Nous recommandons de peindre le produit après le montage. Si le produit est peint en automne, des espaces non peints peuvent s'apparaître pendant le temps des chaleurs extrêmes. Dans ce cas-là il faut les peindre. Si les éléments sont peints avant le montage, il faut les laisser sécher sur une surface plate et protéger contre les facteurs externes de manière à éviter toute déformation des éléments.
12. Le montage des gouttières (non compris) est conseillé.

PENDANT LE MONTAGE :

1. Choisissez une journée chaude et ensoleillée. Les produits en bois doivent être installés dans des températures de 10 à 25°C. Évitez les fortes gelées et la chaleur.
2. Utilisez les règles de sécurité tout au long de votre travail.
3. Montage des lambourdes et du plancher (éléments en option):
 - le plancher peut être en version universelle par colis de 3m² ou il peut se composer des dalles prêtées
 - lors du montage de plancher, suivez toujours les instructions ci-jointes
 - ne pas oubliez de bien isoler le plancher contre le sol et de faire le drainage.

IMPORTANT ! les éléments du plancher misés correctement constituent la base du produit, leur assemblage correct influencera toute la durée de vie du produit.

4. Le montage des parois :

IMPORTANT !

Ne forcez pas sur les pièces pendant le montage - vous risquez de les endommager. Utilisez un maillet en caoutchouc et une planche supplémentaire jointe. La garantie du fabricant ne couvre pas des dommages mécaniques dus au mauvais montage soit pendant l'utilisation du produit.



Attention ! Le bois étant un matériau naturel, des éléments tordus peuvent s'apparaître. Lors du montage, suivez les instructions ci-dessous :

- planifiez la position des pièces tordues en différents endroits pour les adapter au mieux à la construction



- dans le cas de planches tordues, essayez de placer les éléments les plus tordus en bas de la structure



Outils et matériaux dont vous devez disposer :

- A. Planches de protection (y compris)
- B. Cale de frappe (y compris)
- C. Serre joint (non compris)
- D. Maillet en caoutchouc (non compris)

Activités à faire :

1. Protéger les madriers à l'aide des planches de protection
2. Mettre les serres joint en place
3. Frapper le madrier en utilisant la cale de frappe.



- assurez-vous que la languette est toujours posée vers le haut



- la vérification des diagonales des madriers de base est faite (elles doivent avoir toujours la même longueur), des madriers suivants peuvent être installés

- n'oubliez pas de fixer votre abri contre le sol (p.ex. en utilisant des équerres en métal, des plaques métalliques, etc.)

5. Installation de porte et des fenêtres :

- assurez-vous que le cadre de la porte repose sur une surface dure et stable
- avant d'installer la porte et les fenêtres, vérifier la verticale et le niveau des parois afin d'atteindre le montage correct et bon fonctionnement des fenêtres et de porte
- suivez toujours les instructions de la notice
- enlevez le film de protection avant d'installer le plexiglass
- les lattes et les meneaux sont pré-taillés, triez -les et faites correspondre leur taille à la croisée de la porte et de la fenêtre avant l'assembler. Si nécessaire, coupez les lattes avec précaution. Les clous de fixation doivent être martelés avec un petit marteau de rembourreur à une distance d'au moins 30 mm de l'extrémité de la planche.

6. Installation du toit à pignon :

IMPORTANT! Utilisez une échelle pour assembler le toit. Ne montez pas sur le toit ! Monter sur le toit est permis conditionnellement lors de l'installation du feutre bitumeux/bardeau et seulement lorsque le toit est entièrement installé, tout en respectant la charge maximale du toit.

- il est recommandé de fixer les pannes faîtières suivant le plan ci-dessous.



- lors de la pose des planches de toit, n'oubliez pas de laisser des espaces de 1-2 mm entre eux, ce qui facilitera le travail du bois et ne provoquera pas des déformations pendant le temps humide

- façon de fixation des planches :



IMPORTANT : la charge sur le toit ne doit pas excéder 25 kg / m². La neige, la glace, les feuilles, etc. doivent être enlevés systématiquement.

7. Installation du toit appenti :

IMPORTANT ! Utilisez une échelle pour assembler le toit. Ne montez pas sur le toit ! Monter sur le toit est permis conditionnellement lors de l'installation du feutre bitumeux/bardeau et seulement lorsque le toit est entièrement installé, tout en respectant la charge maximale du toit.

- Les pannes faitières doivent être fixées suivant le plan ci-dessous.



- lors de la pose des planches de toit, n'oubliez pas de laisser des espaces de 1-2 mm entre eux, ce qui facilitera le travail du bois et ne provoquera pas des déformations pendant le temps humide

- façon de fixation des planches :



IMPORTANT : la charge sur le toit ne doit pas excéder 25 kg/m². La neige, la glace, les feuilles, etc. doivent être enlevés systématiquement.

8. Couverture du toit (sous-couche de feutre bitumeux) :

- une fois le montage du toit est fini, le feutre bitumeux doit être posé
- faire chevaucher le feutre bitumeux suivant la notice
- en cas de détérioration du feutre, remplacez la pièce endommagée par une nouvelle
- vous pouvez couvrir le feutre bitumeux par des bardeaux ou un autre matériau léger de votre choix, en tenant compte de la charge maximale de 25 kg/m² et en garantissant l'étanchéité du toit
- un contrôle régulier de la couverture est nécessaire

9. Lattes anti-tempête

- en fixant les lattes anti-tempête, percez un trou de 8 mm dans la partie supérieure de l'abri et montez-les conformément à la notice. Serrer le boulon à la main, le boulon pourra bouger facilement dans l'ouverture ovale pendant le "travail" des parois. Fixez la latte en bas avec un vis.



ENTRETIEN DU PRODUIT :

1. N'oubliez pas qu'un traitement régulier du bois et l'enlèvement systématique des ordures autour du produit sont nécessaires. N'oubliez pas que le produit en version non traitée doit être protégé immédiatement. Il est recommandé d'appliquer le traitement supplémentaire une fois par an. Il est recommandé de maintenir la continuité du traitement supplémentaire une fois par an. ATTENTION ! Pour maintenir la garantie, sauvegardez les reçus d'achat de l'imprégnation.

2. Utilisez des produits de bonne qualité pour bien protéger le bois.

3. Vérifiez l'état technique du produit au moins une fois par an :

- faites attention à l'étanchéité de la couverture, remplacez si nécessaire le feutre bitumeux par un élément neuf
- vérifiez que le produit est suffisamment ventilé (installer des grilles de ventilation si nécessaire pour éviter l'humidité)
- vérifiez le fonctionnement des éléments en marche (portes, fenêtres)
- graissez la serrure et les charnières

4. En hiver, enlever systématiquement la neige du toit. Ne laissez dépasser 25 kg/m².

5. Gardez toujours la propreté à l'intérieur et à l'extérieur du produit acheté. N'oubliez pas que les feuilles, les branches, l'herbe ou l'eau peuvent influencer une dégradation du bois plus rapide.

6. Ne serrez pas ou ne vissez pas les planches parois ensemble car cela empêcherait le bois de travailler. À l'exception des modèles d'abris avec une construction spéciale, où cela est indiqué dans les instructions de montage.





7. N'accrochez pas les placards aux parois, ne vissez pas les étagères.

8. Laissez sous le toit un espace libre pour la ventilation et le travail du bois.

GARANTIE :

Le bois est un matériel vivant qui travaille avec les changements de température et d'humidité. Bien que nous faisons une grande attention sur la qualité du bois utilisé pour nos produits, nous ne sommes pas capables diminuer complètement les processus naturels ci-dessous.

Trait naturel du bois	Photo	Consignes
le changement de couleur avec du temps, des différences de teinte et de structure		Utiliser les produits du traitement de bois selon les indices du fabricant.
tous les noeuds avec la diamètre au 2 cm ainsi que les noeuds naturels, sains (couleur foncé ou pâle) et supérieurs à 2 cm		On peut utiliser le mastic pour bois ou le silicone.
les fissures et les fentes		Les fissures et les fentes ont un caractère saisonnier. Ils travaillent avec le changement d'humidité. On peut utiliser le mastic pour bois ou le silicone.
l'entre-écorce		On peut utiliser le mastic pour bois ou le silicone.

<p>les poches et les remontées de résine</p>		<p>La résine sec peut être enlevée à l'aide d'une spatule en prenant soin de ne pas endommager la structure bois.</p>
<p>les remontées de sels</p>		<p>Utiliser un solvant à base d'acétone, de térébenthine ou d'essence pour les nettoyer. Après lessivage, laver plusieurs fois avec de l'eau tiède et une petite quantité d'acide acétique.</p>
<p>le bleuissement</p>		<p>Utiliser les produits accessibles sur le marché selon les indications du fabricant.</p>
<p>la moisissure</p>		<p>Utiliser les produits accessibles sur le marché selon les indications du fabricant.</p>

La garantie s'applique à (valable uniquement avec une preuve d'achat) :

1. la protection du bois contre les insectes (hors termites, fourmis et abeilles australiens) et les champignons pendant **2 ans** si les conditions suivantes sont remplies :
 - le produit acheté en version non traité a été traité à l'aide des moyens de traitement / des teintures pour la protection du bois accessibles au marché, au plus tard le jour du montage effectué
 - le bois n'a pas de contact direct avec le sol et de l'eau (y compris aussi le système d'arrosage)
 - le bois est traité chaque année à l'aide des moyens de traitement / des teintures pour la protection du bois accessibles en marché

**ATTENTION : sans protection annuel du bois la garantie arrive à expiration.
Souvenez-vous de sauvegarder les preuves d'achat d'imprégnants.**

2. les vices de fabrications et les éléments manquants – 1 an pour la quincaillerie (la garantie s'applique uniquement avant le montage) – la garantie se limite à l'échange des éléments défectueux (la réparation ou tout autre dommage causé par un élément défectueux sont exclus)
3. les vices de fabrications et les éléments de construction manquants (la garantie s'applique uniquement avant le montage) – la garantie se limite à l'échange des éléments défectueux (la réparation ou tout autre dommage causé par un élément défectueux sont exclus)
4. cette garantie est valable uniquement dans le pays où l'achat a été réalisé.
5. la garantie ne s'applique pas si le produit a subi des modifications.
6. les interventions sous garantie ne prolongent pas la durée de cette garantie

La garantie ne couvre pas :

- les traits naturels du bois décrits ci-dessus
- la déformation naturelle causée p.ex. par l'exposition prolongée au soleil
- les éléments voilés ou courbes qui permettent de monter le produit
- les dommages et les défauts causés par un stockage, un assemblage, une utilisation et / ou un manque d'entretien inadéquats
- la corrosion de quincaillerie
- les éléments collés (par ex. aboutés)
- les dommages provoqués par une mauvaise préparation du terrain
- les dommages dûs à l'intervention des tiers non autorisés
- les dommages résultant de l'utilisation à des fins publiques ou commerciales

- les dommages causés par des forces majeures telles que les tremblements de terre, les incendies, les glissements de terrain, les inondations, les tempêtes, les vents ou les grêles ou autres précipitations et phénomènes atmosphériques
- les dommages causés par les termites, les fourmis ou les abeilles australiennes
- les défauts visibles que l'acheteur doit remarquer lors de la livraison
- les coûts de main-d'œuvre, du transport, etc. (ils sont à la charge de l'acheteur)
- dommages causés par les inondations, les fuites (également dues à une mauvaise installation de la toiture)

En prenant en compte le travail permanent du bois les dimensions communiquées sont juste données à titre indicatif (elles peuvent varier de ± 2 à 12% en fonction de la section et de la direction mesuré).

CARACTERISTIQUES TECHNIQUES DU PRODUIT

IMPORTANT :

Le bois est un matériau vivant, il est donc naturel qu'il travaille avec l'humidité et la température. Bien que nous attachions une grande importance à la qualité du bois utilisé dans nos produits, nous ne pouvons pas éviter certains phénomènes qui constituent les caractéristiques naturelles du bois : changements de couleur, nœuds naturels, fissures, entre-écorce, résine, coulées de résine, remontées de sel, bleuissement, moisissures superficielles ou coubures qui n'empêchant pas l'assemblage.

Il faut être bien conscient que le bois n'est pas un matériau hermétique et étanche et qu'il se caractérise même par une hygroscopicité élevée. Par conséquent, en cas de fortes pluies ou d'une humidité de l'air élevée, il existe un risque de pénétration de l'eau.

Afin de minimiser l'absorption du bois, vous pouvez utiliser des produits prévus pour ce phénomène come p.ex. des huiles de cire.

Quant aux abris de jardin, où nous voudrions garder l'étanchéité, vous pouvez remplir les fentes à l'aide du géotextile, de la laine minérale ou des inserts en caoutchouc soit en laine, ainsi que des produits synthétiques, par exemple, silicone ou masse pour l'étanchéité des matériaux en bois, qui conviennent également à la fixation des joints, par exemple dans les coins de l'abri.

IMPORTANT ! les travaux supplémentaires, tels que l'étanchéité, vous exécutez vous-même et sous votre propre responsabilité. Suivez toujours les recommandations du fabricant d'un produit choisi. Rappelez-vous que l'étanchéité du produit implique également l'obligation d'utiliser une ventilation adéquate.

Une partie des éléments utilisés par nous est collée. Ce bois est plus durable que le bois massif et moins subit à la torsion et au gauchissement.

DOM118-2

300x300cm

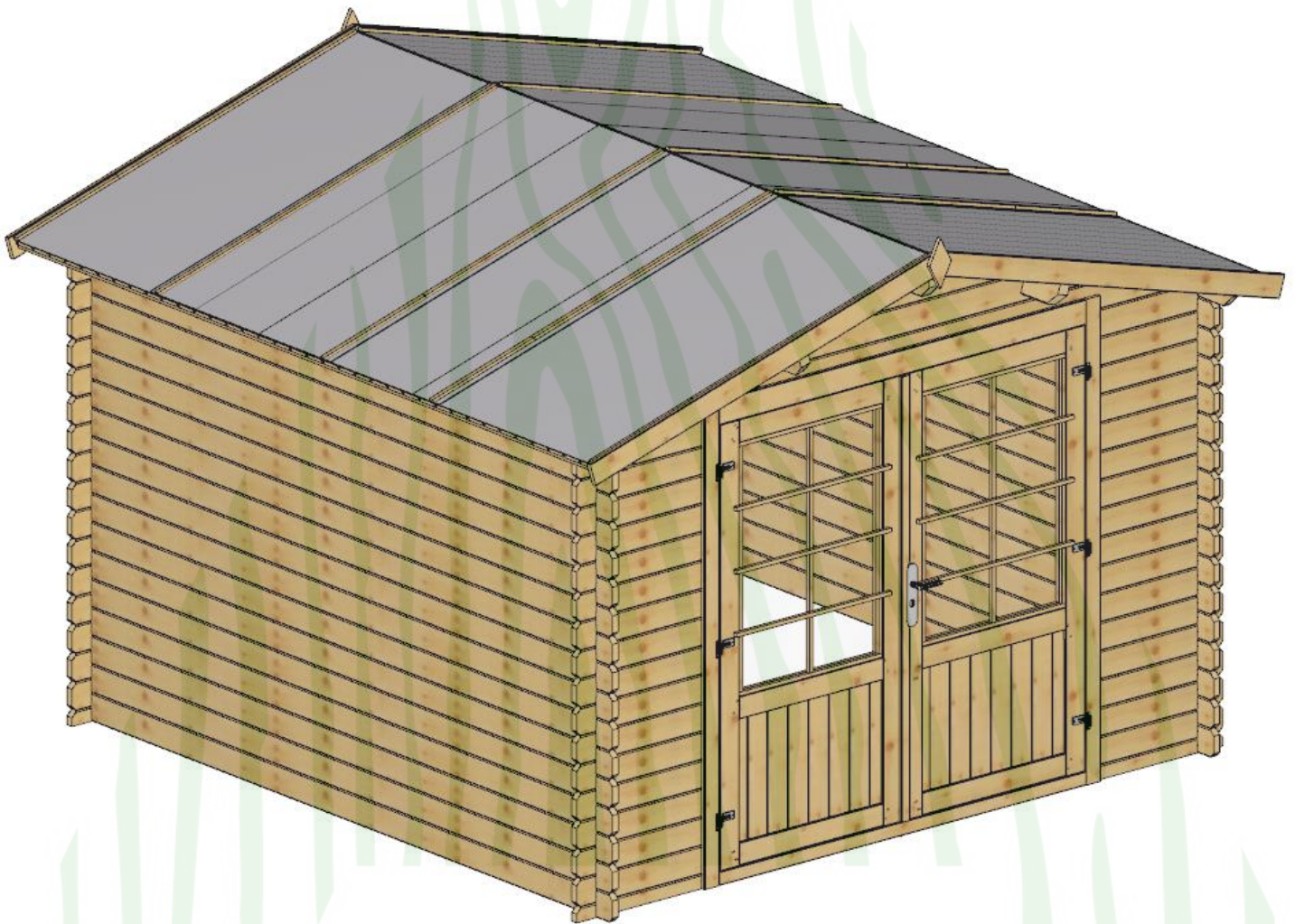
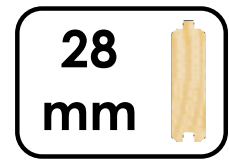





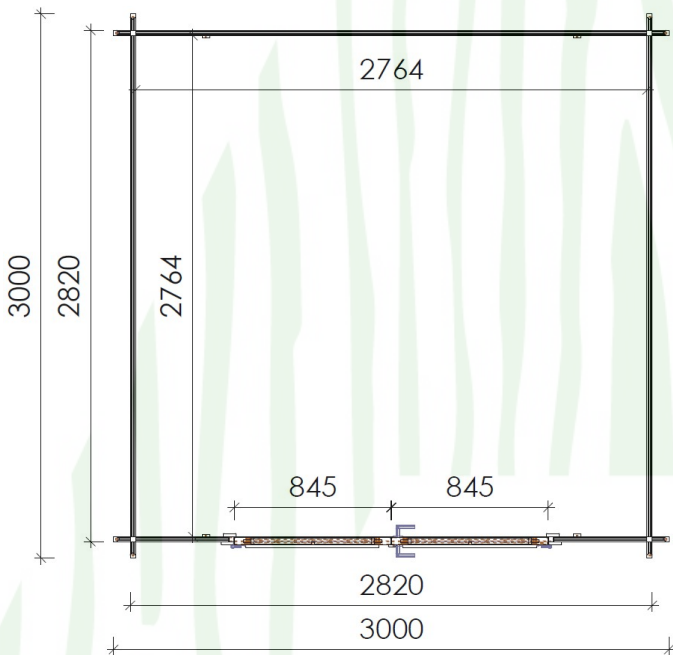
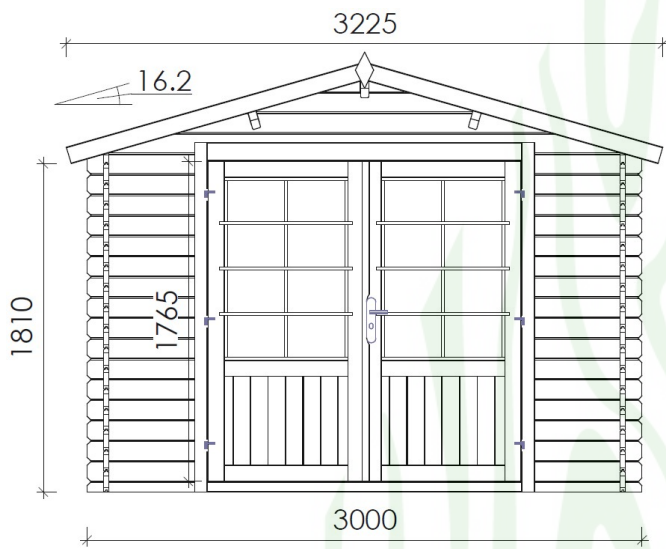































DOM118-2 300x300 28mm



DOM118-2 300x300 28mm

nr	Element	Size (mm)			pcs	miss	dama- ged
		d	h	L			
1		28	121	3000	48		
2		28	113	3200	2		
3		28	65	3000	1		
4		28	65	3000	1		
5		28	121	622	32		
6		13	45	2000	4		
7	SZC21-1 	28	453	3000	2		
8		45	145	3200	3		
9	OSCP01 	61	82	1926	1		
10	OSCL01 	61	82	1926	1		
11	NAD01 	61	112	1746	1		
12	PRO01 	16	55	1700	1		
13	DRZ03-4 	38	845	1765	1		
14		16	99	1640	72		
15		13	22	1150	26		
16		16	95	1680	4		
17		16	110	165	2		
18		3	1000	3750	4		
19		16	16	1000	30		
20	plexiglass 	1,5	660	1000	2		
21		19	19	1900	4		

nr	Element	Size	pcs	miss	dam.
A		3,5x25	129		
B		3,5x35	58		
C		3,5x40	28		
D		5,0x100	6		
E		1,6x30	102		
F		2,0x40	464		
G		6,0x50	4		
H		M6	4		
I		Ø6	4		
J		15x15x15	16		
K			1		
L			1		
M			6		
N		L-50	2		

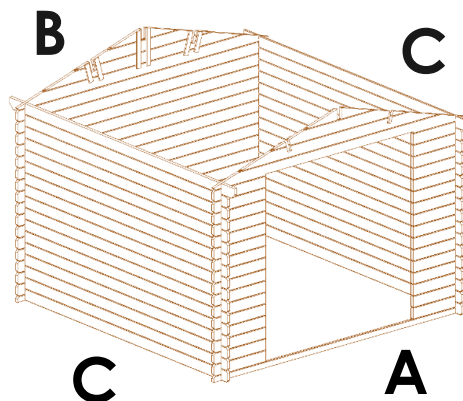
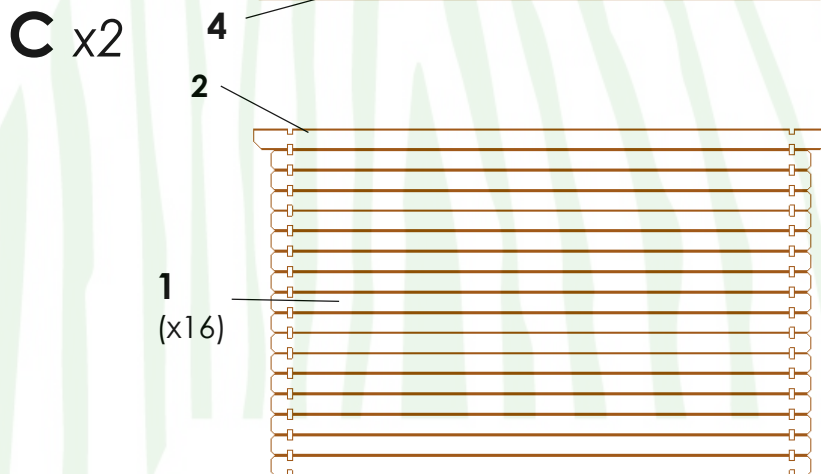
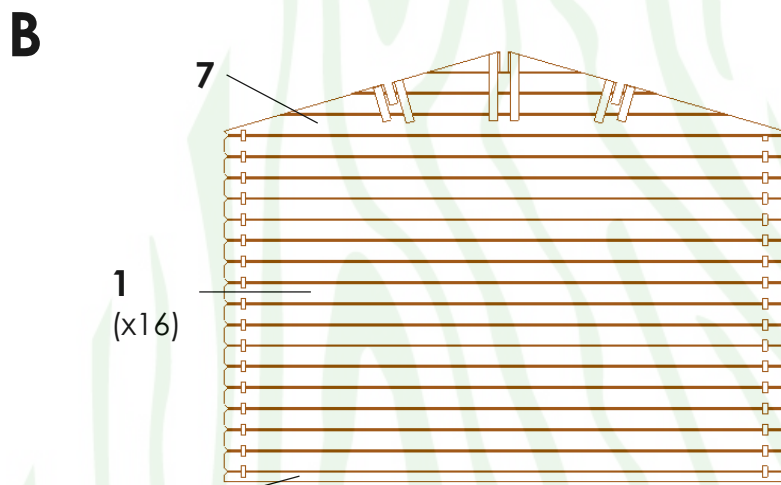
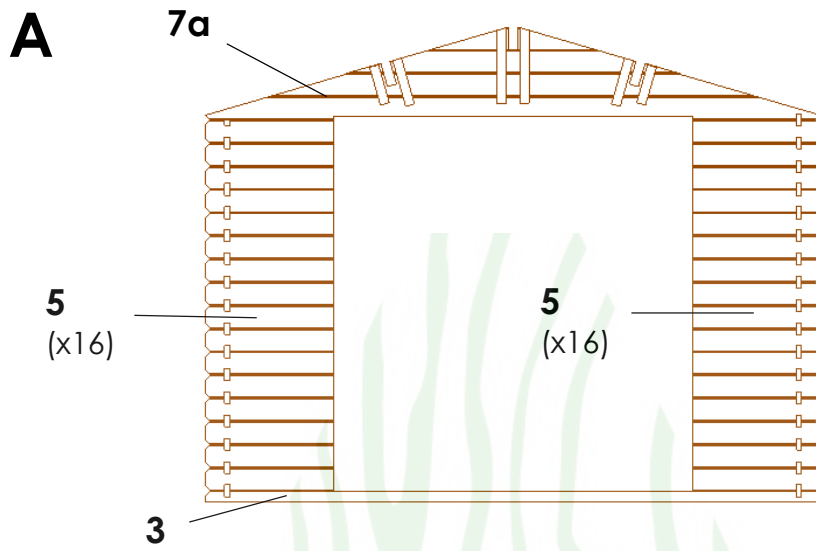

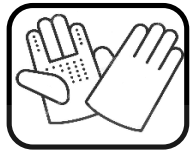
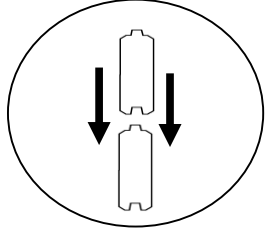
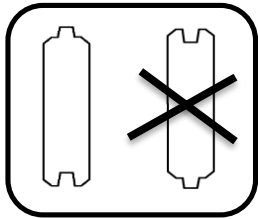
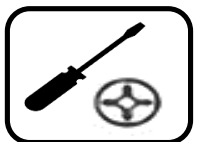
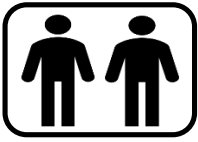

min. 100mm

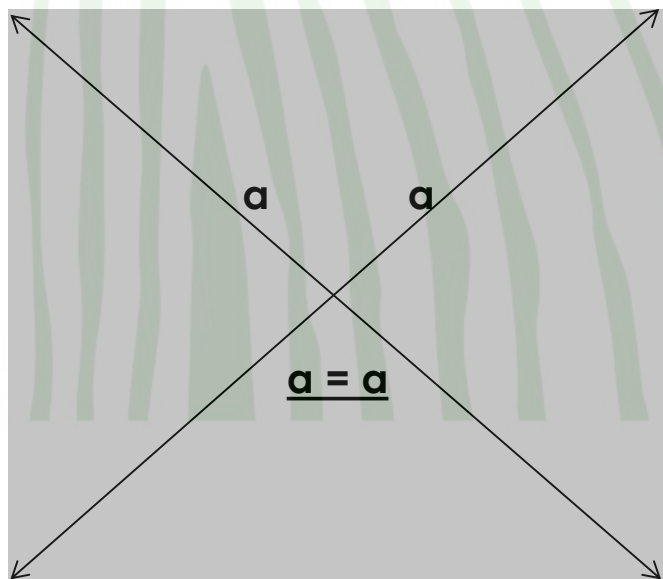

2820 mm

2820 mm

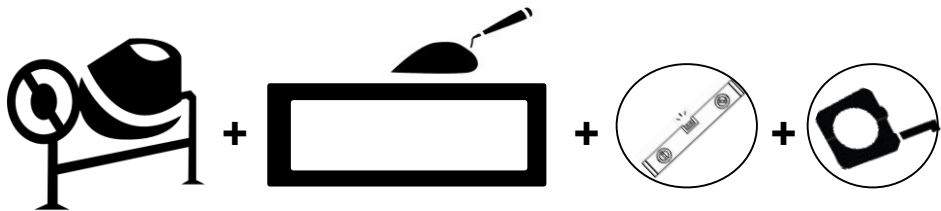

1

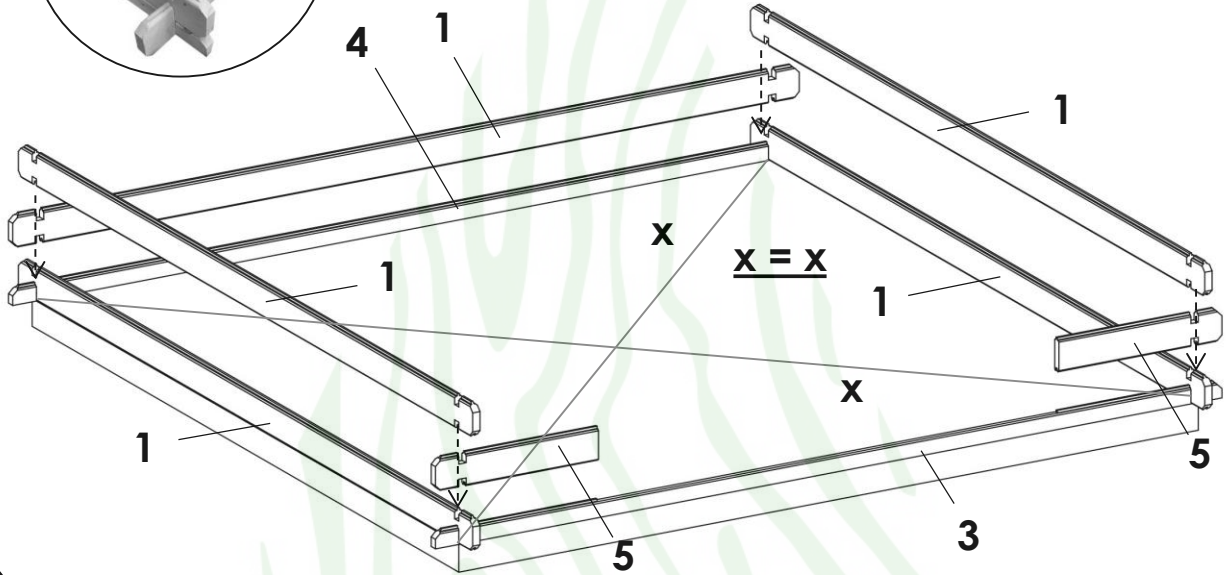
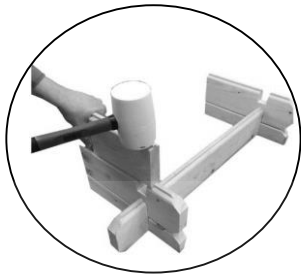

2

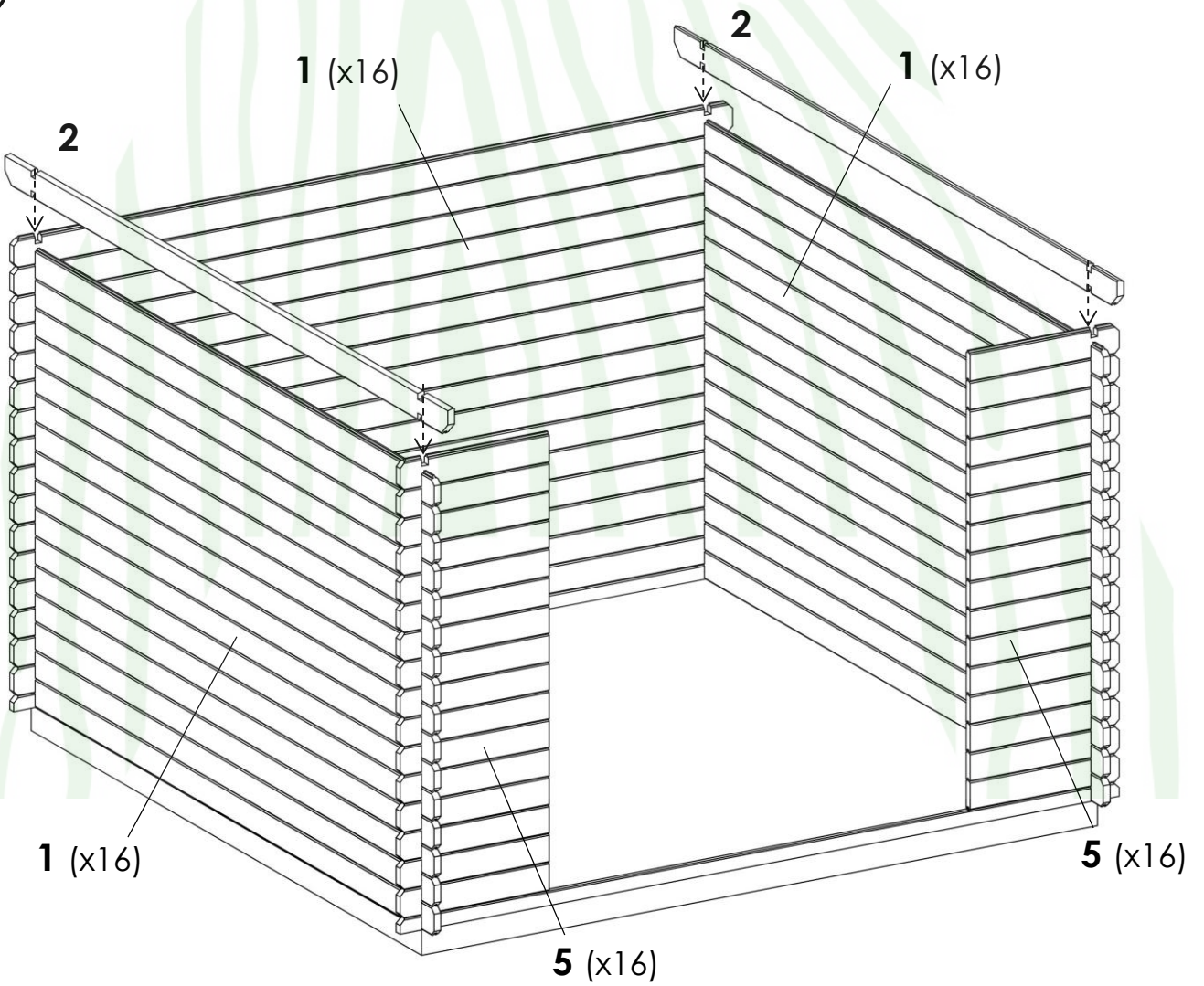

3

1x
7→7a

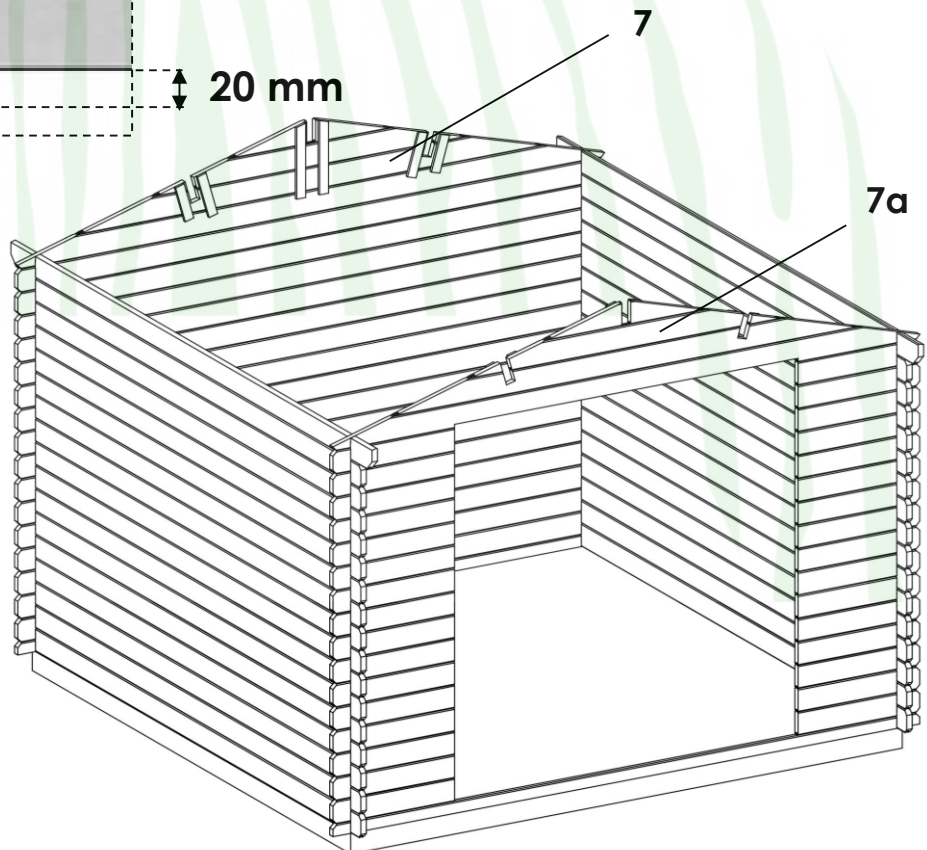
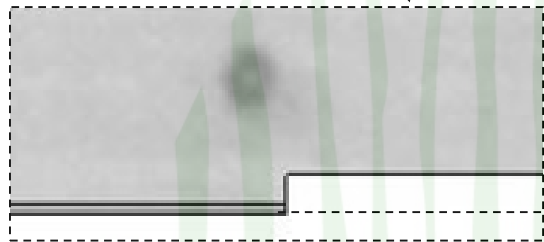
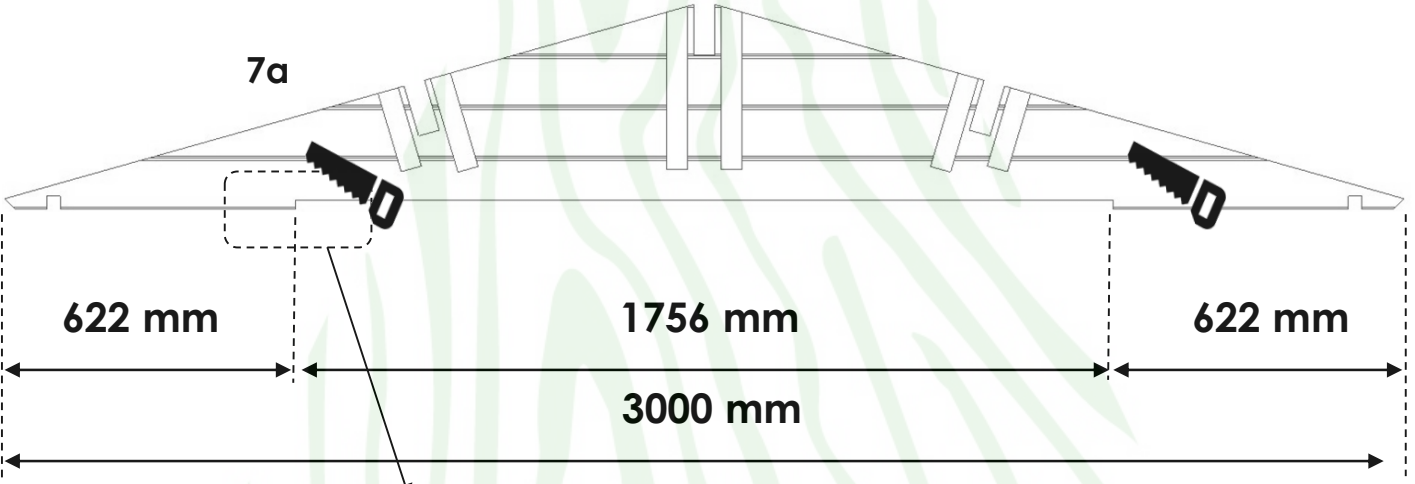
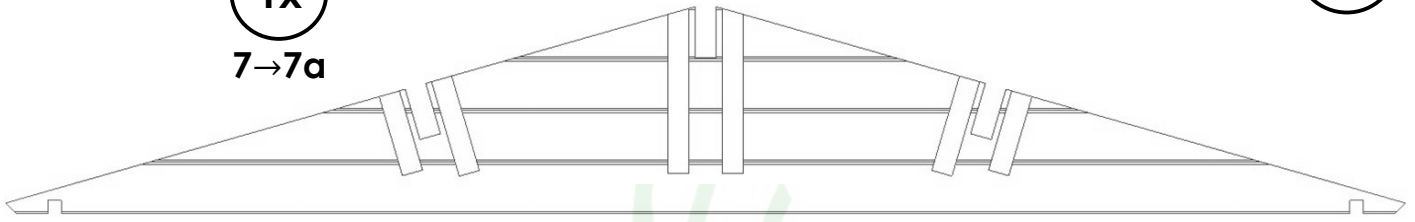

4

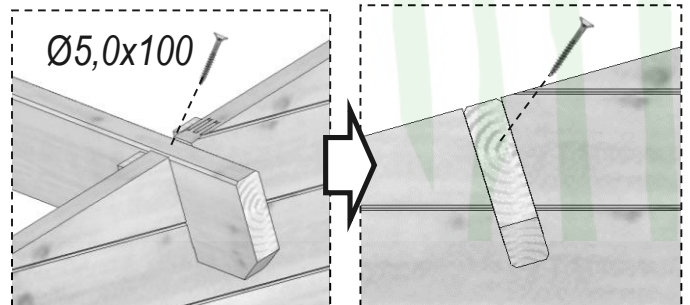
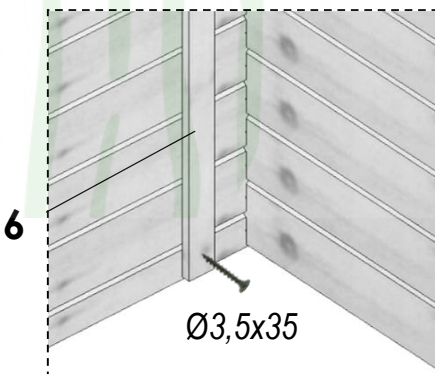
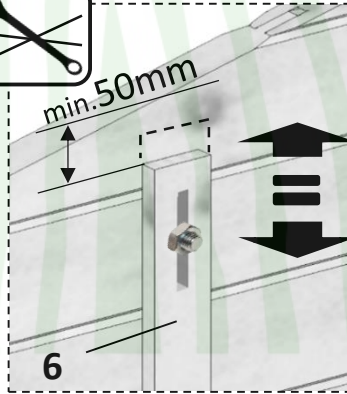
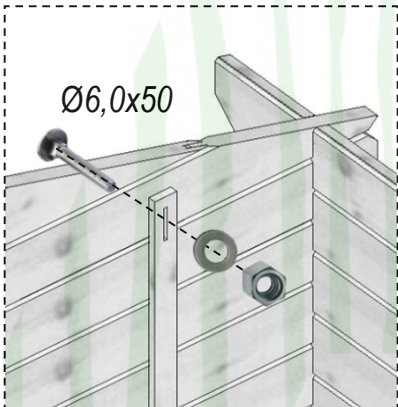
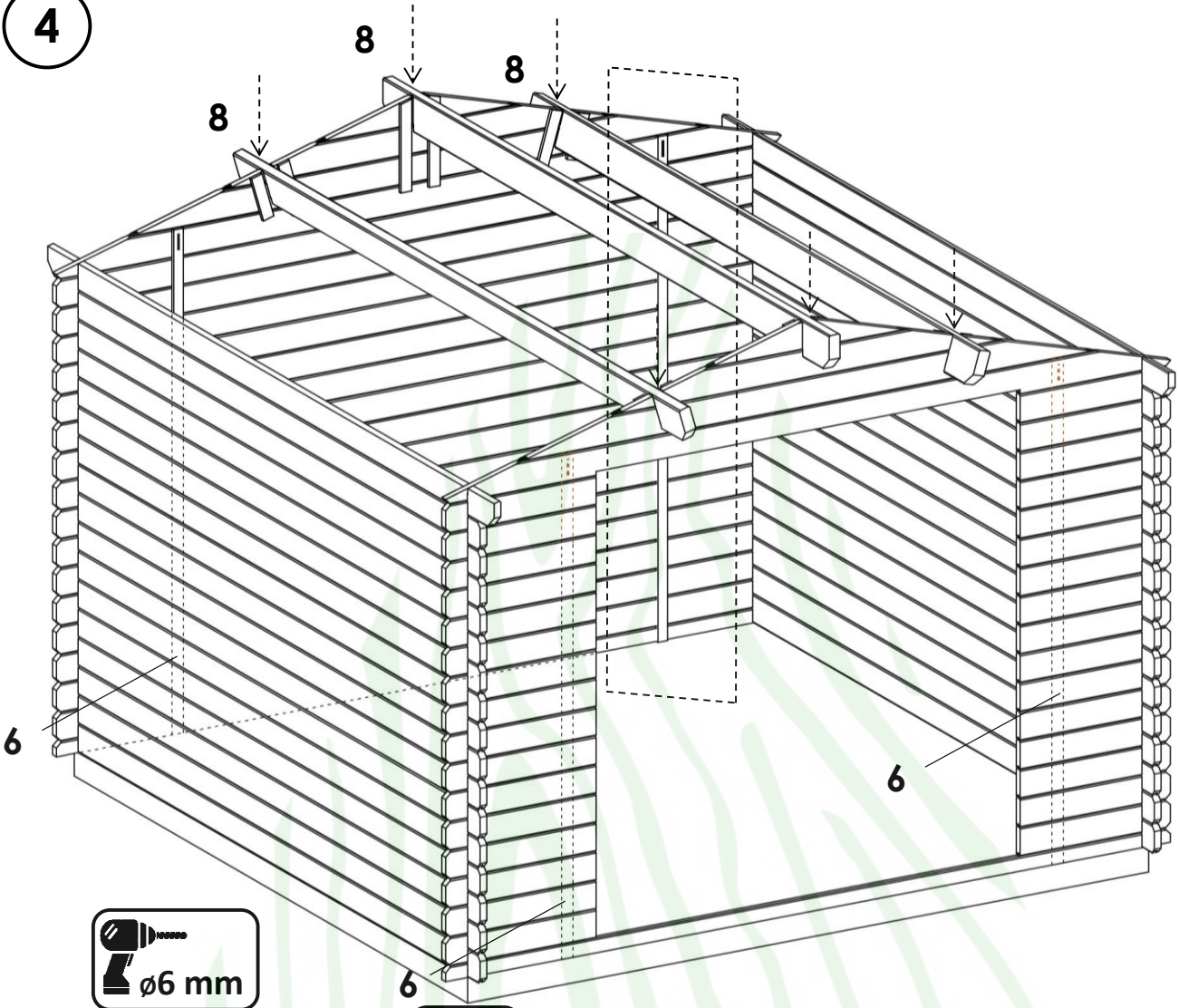

- $\varnothing 5,0 \times 100$ (x6)
- $\varnothing 6,0 \times 50$ (x4)
- $\varnothing 3,5 \times 35$ (x4)



Ø2,0x40 (x2)

14

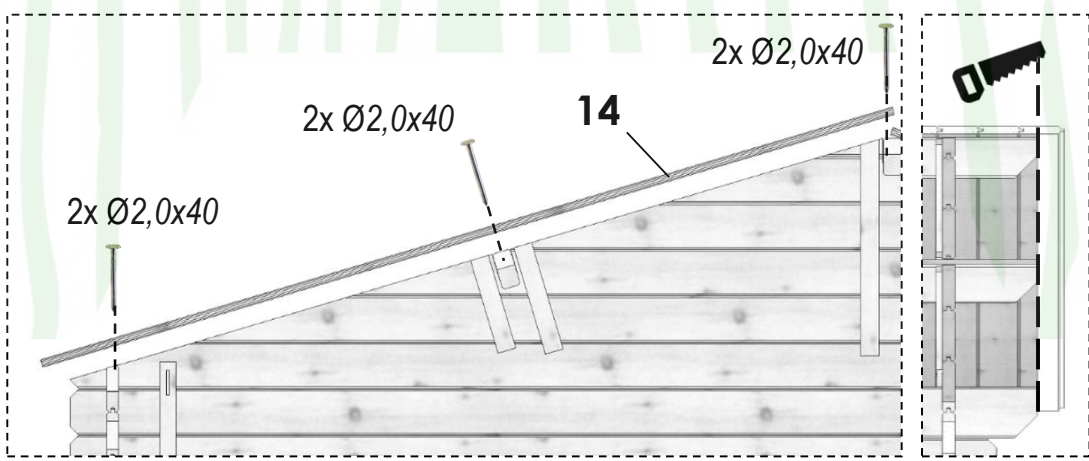
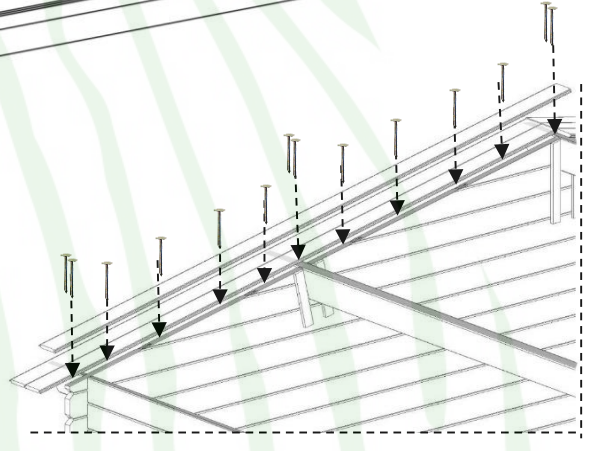
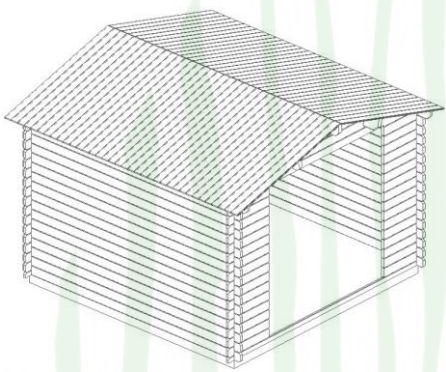
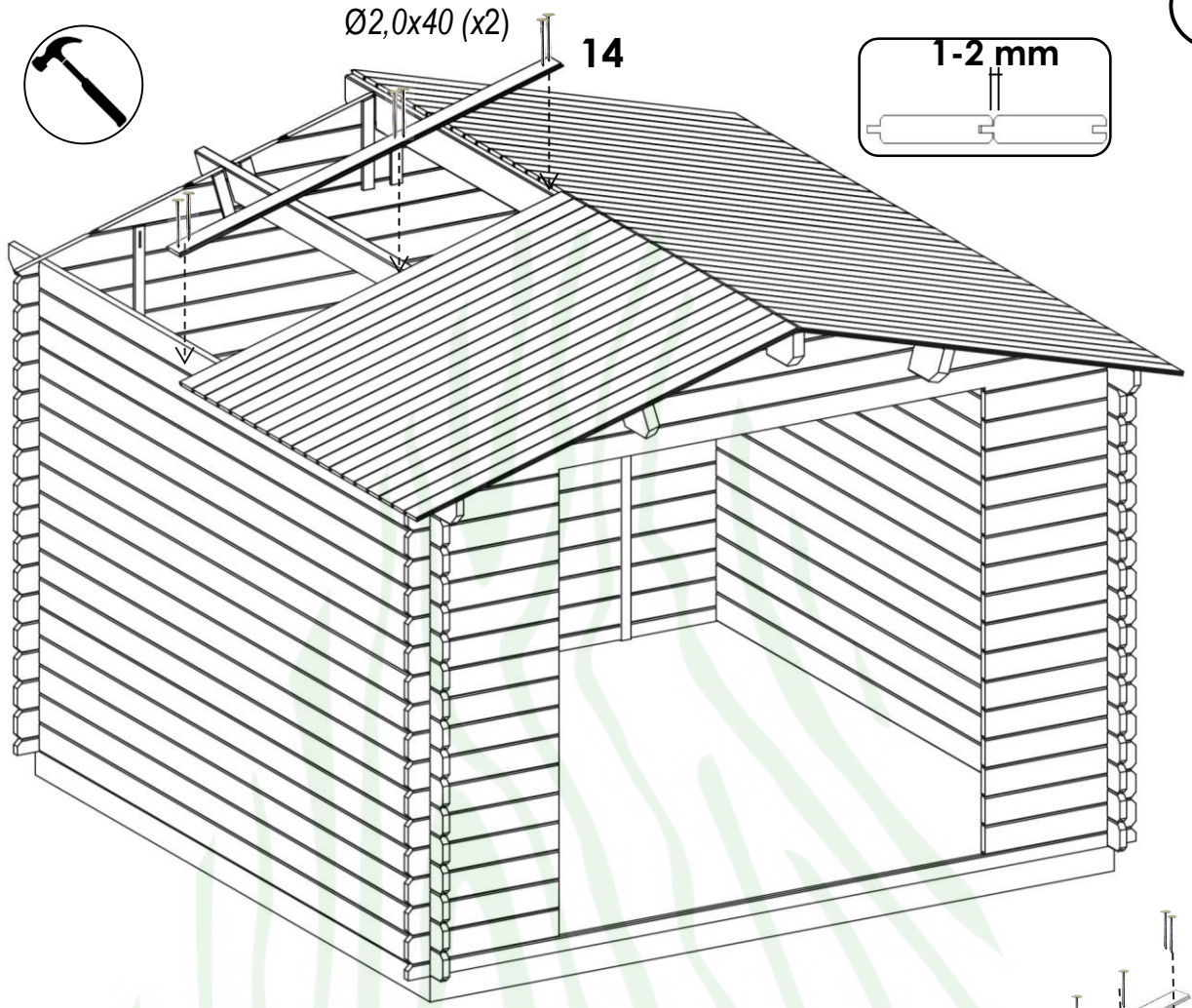
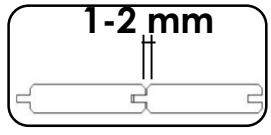

Ø2,0x40 (x464)

6

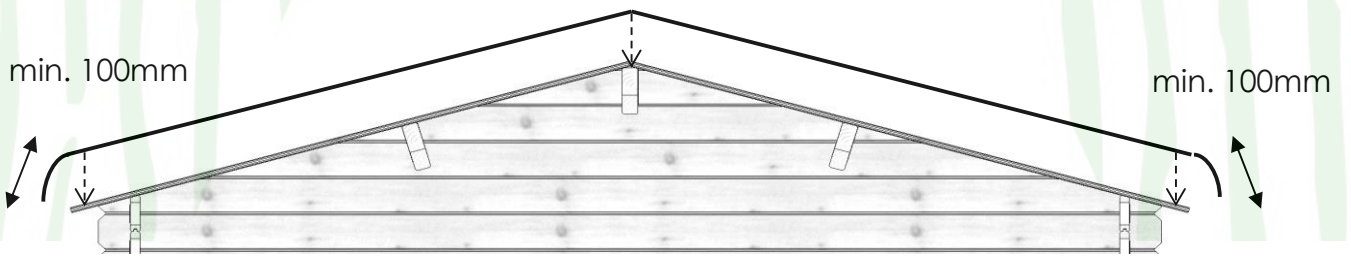
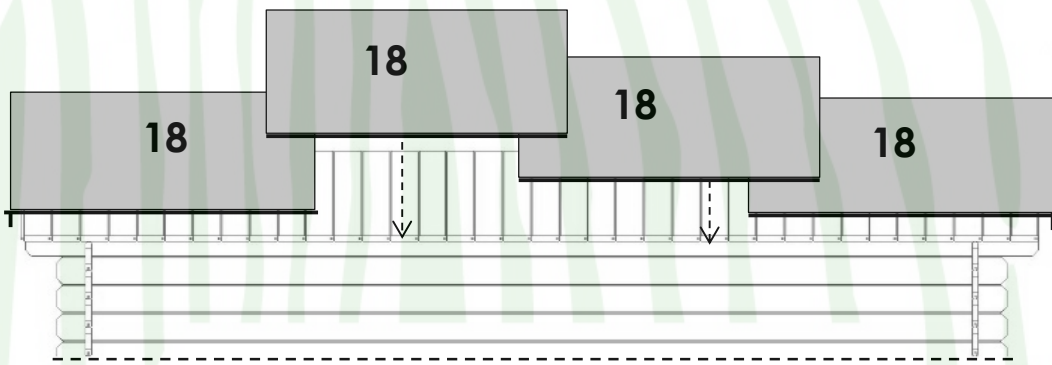
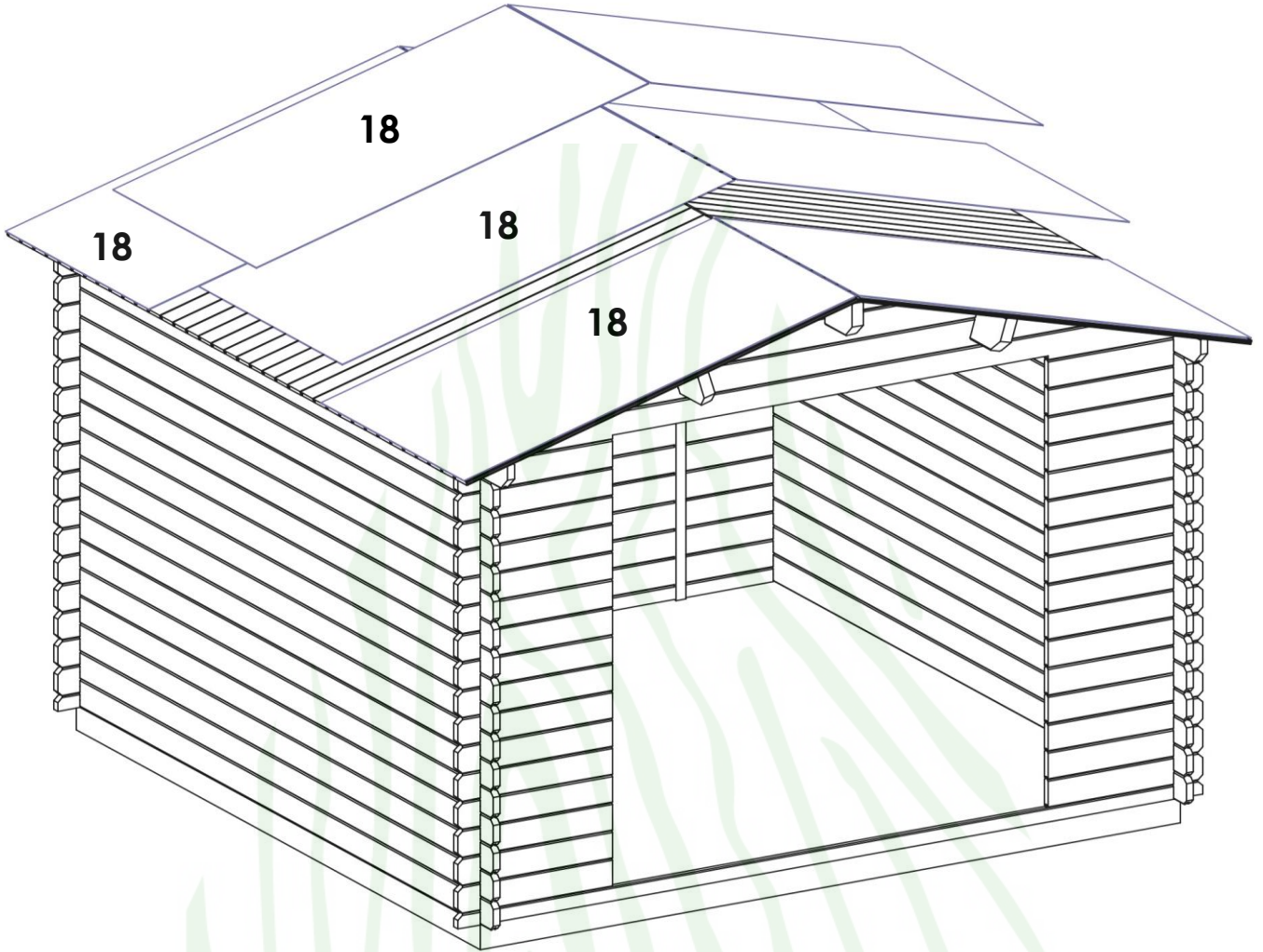

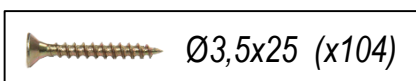
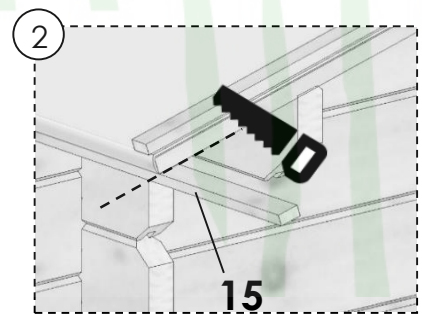
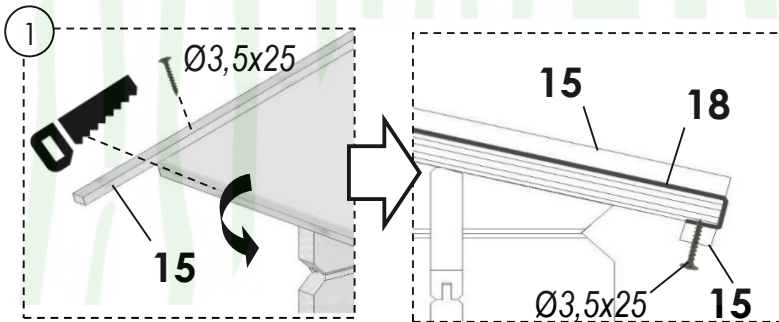
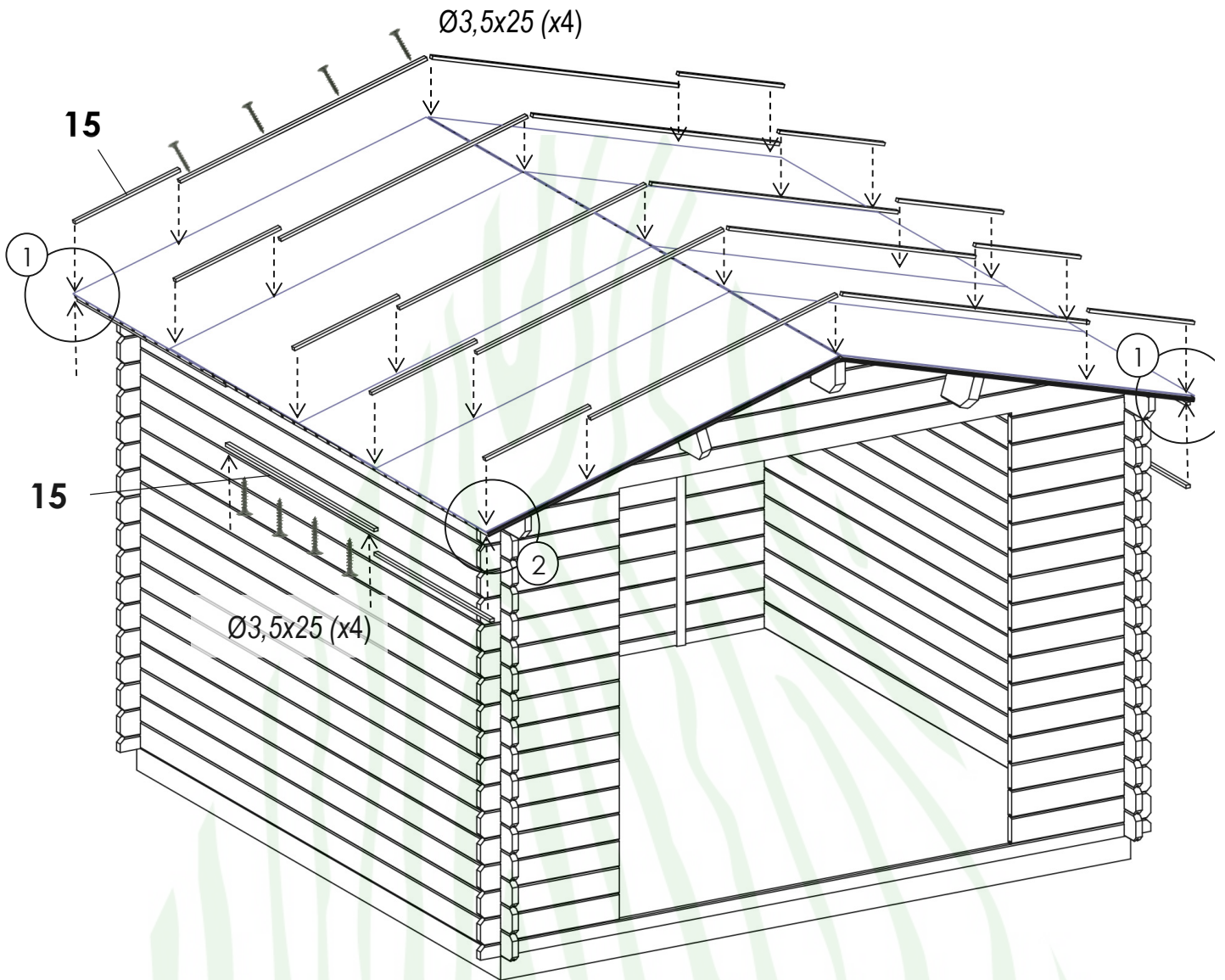

8

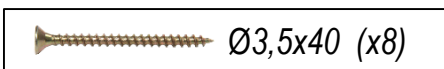
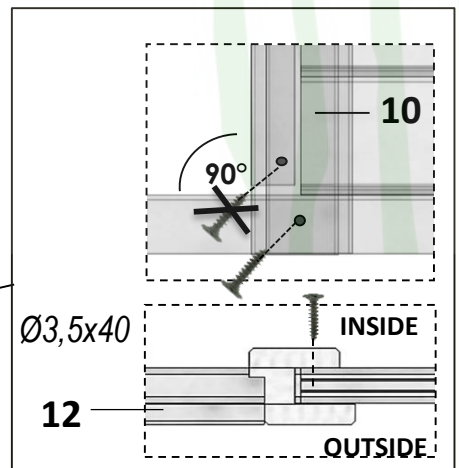
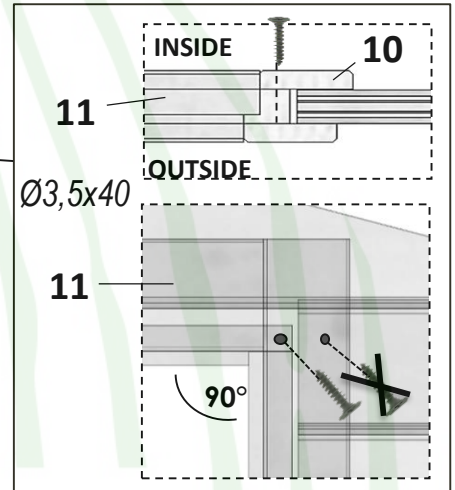
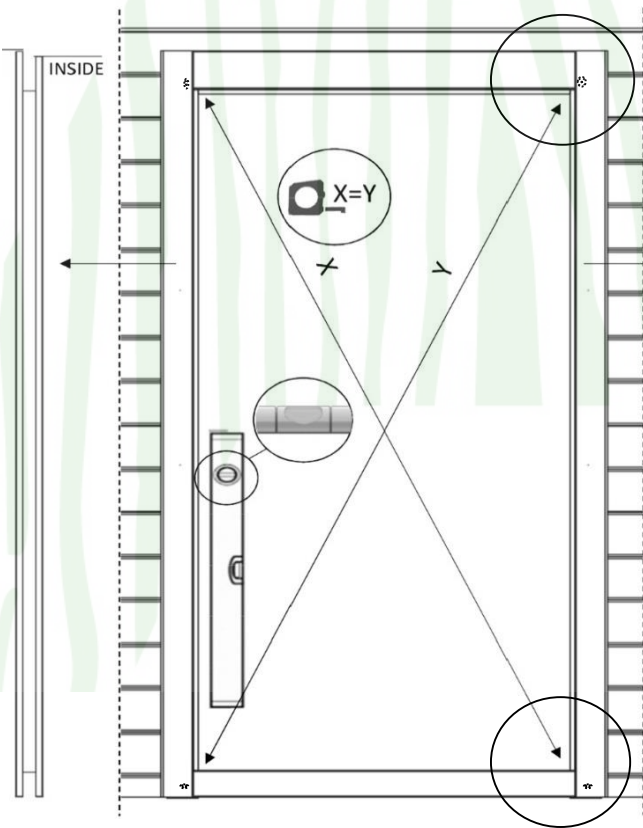
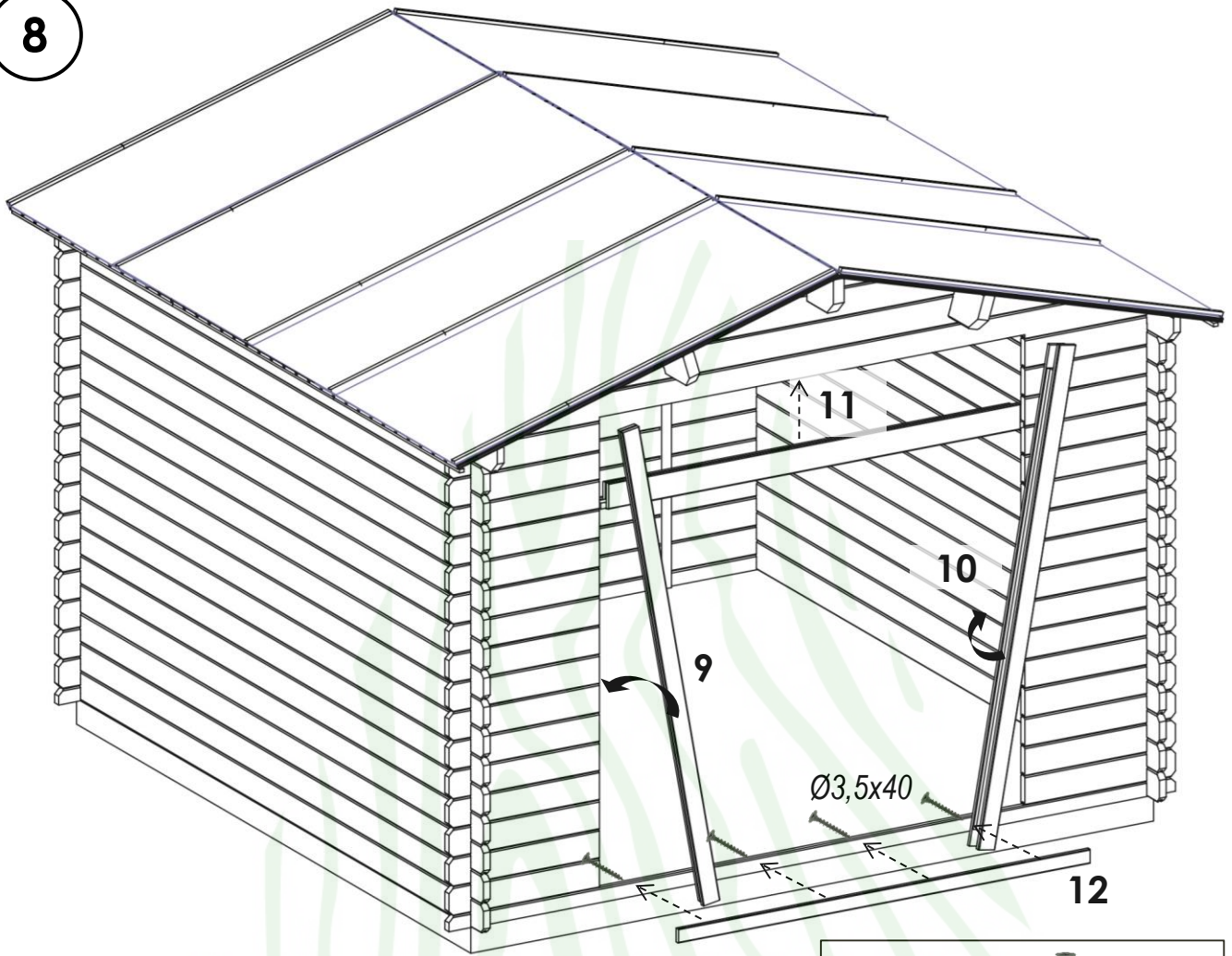

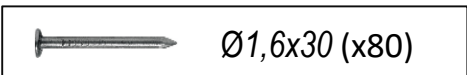
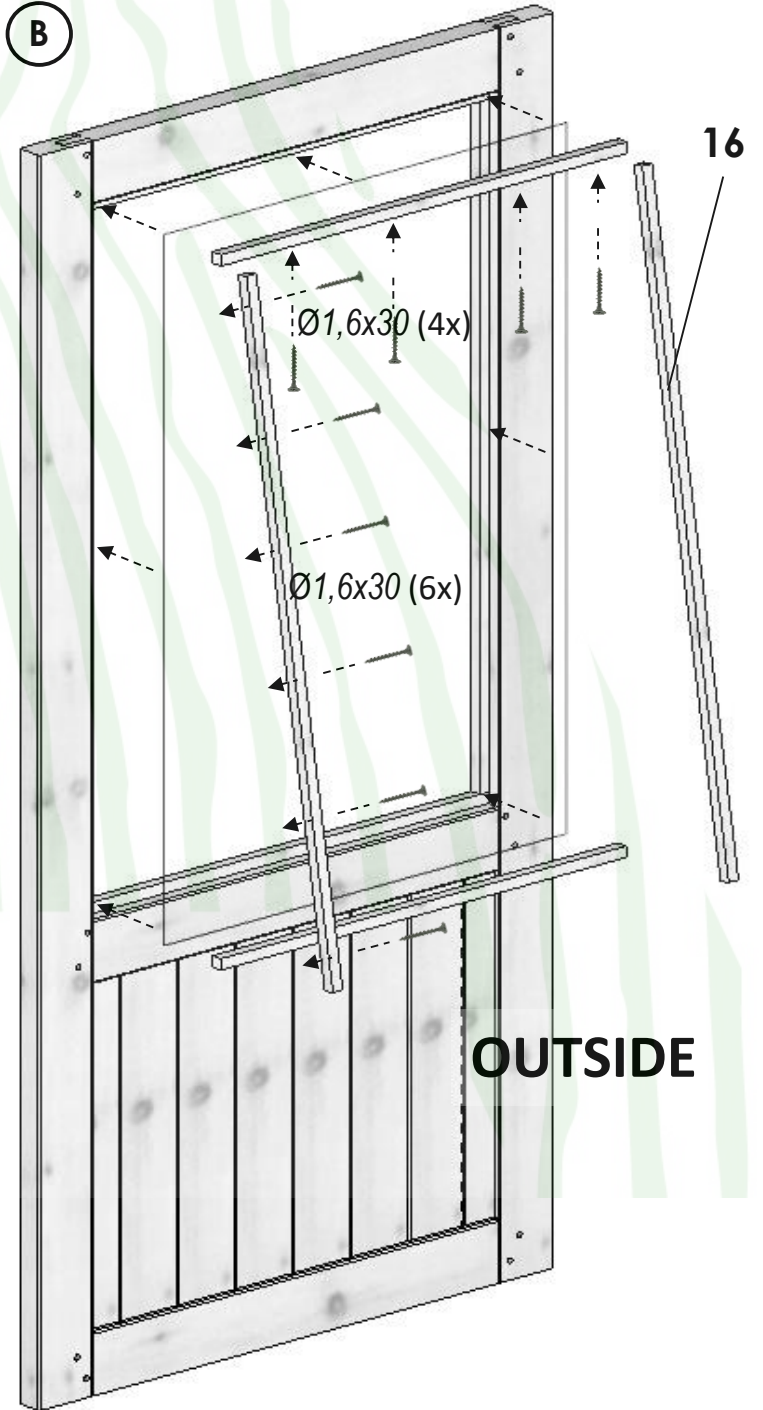
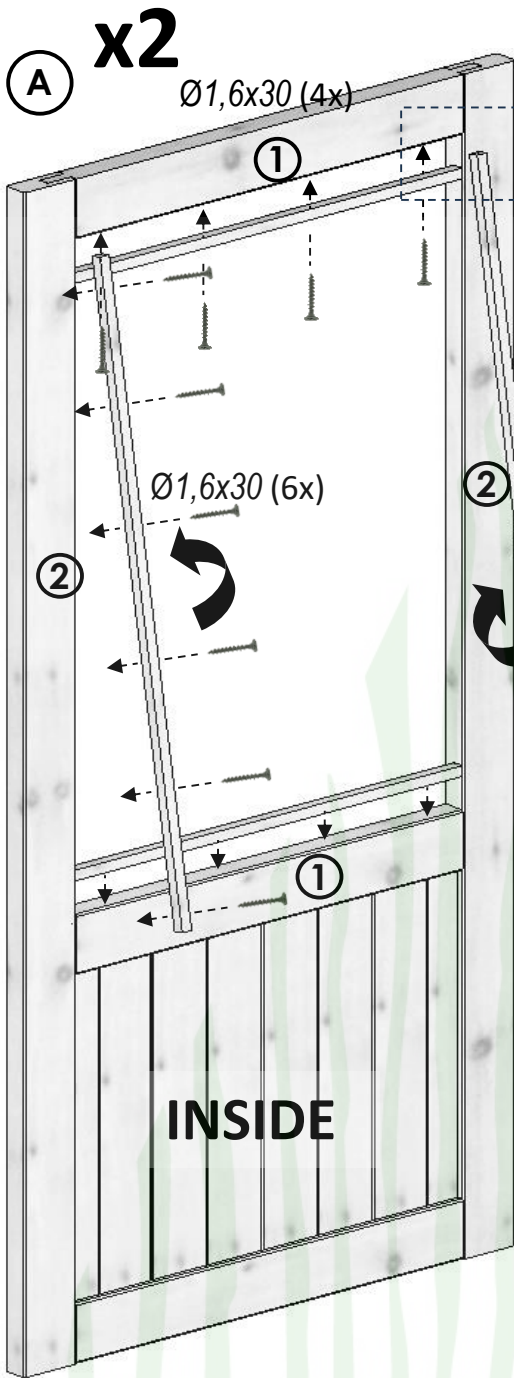

10



x2

Ø1,6x30 (11x)

OUTSIDE

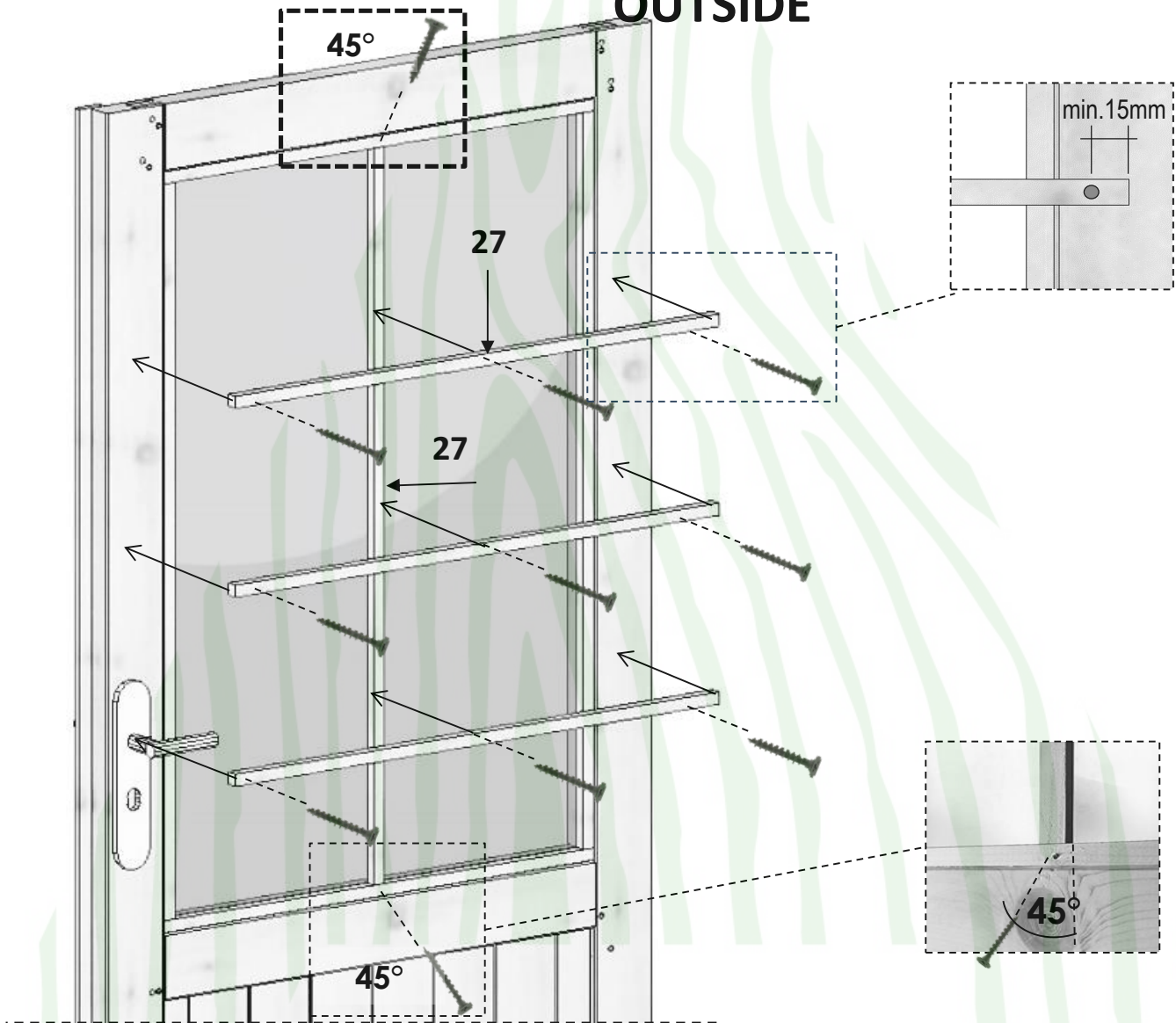

 Ø1,6x30 (x22)

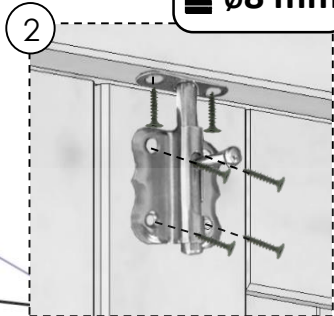

INSIDE Ø3,5x35 (x6)

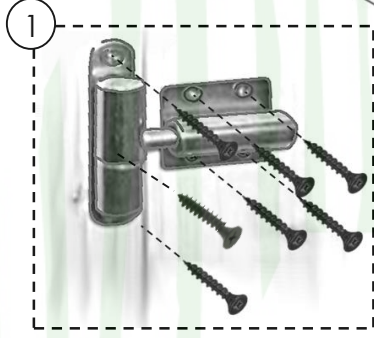
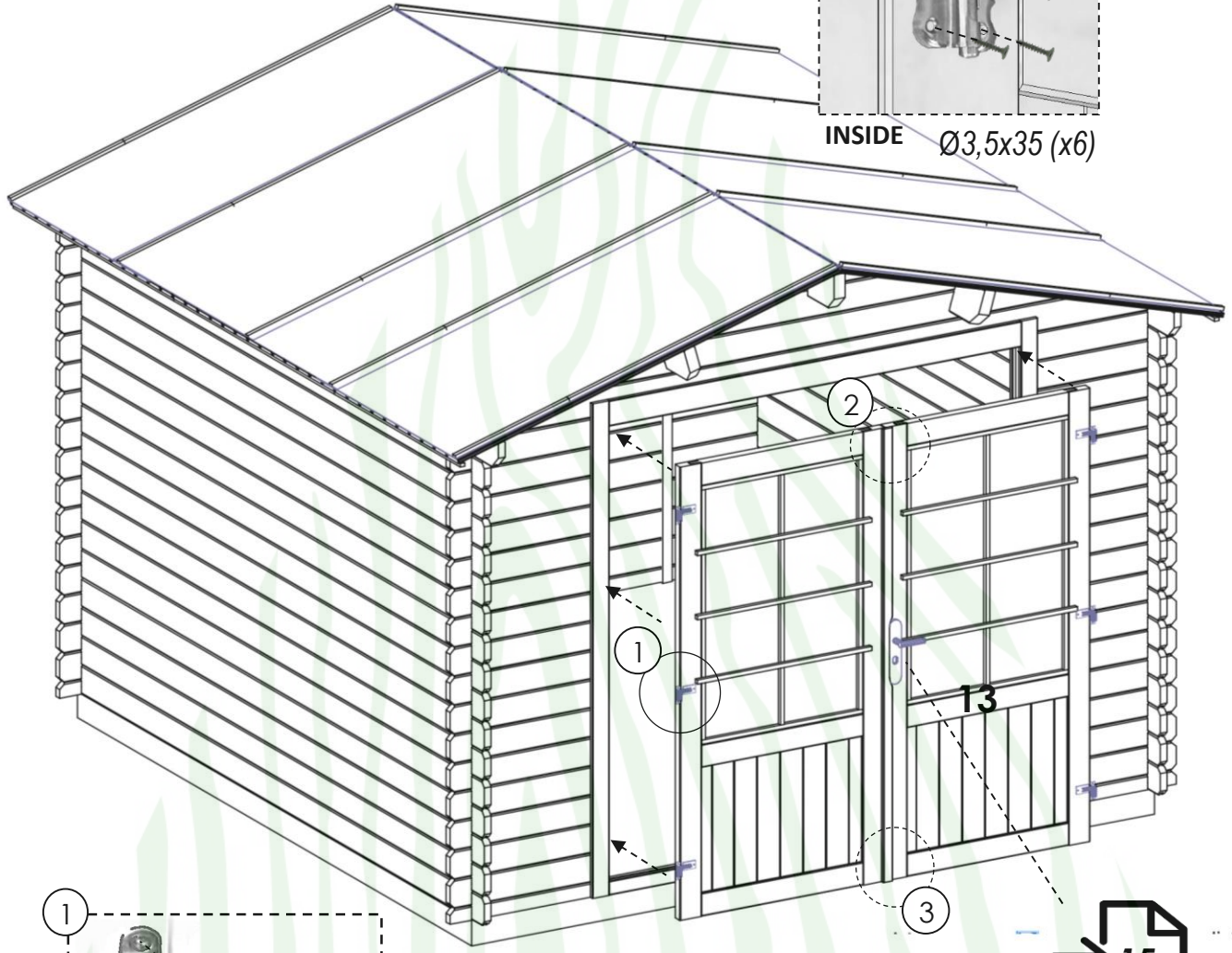

OUTSIDE Ø3,5x35 (x7)

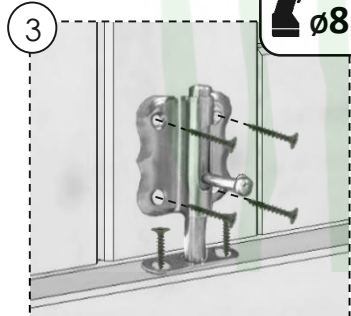
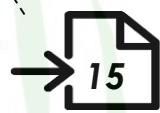

INSIDE Ø3,5x35 (x6)

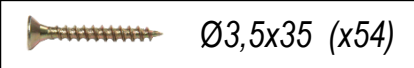

12

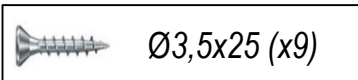
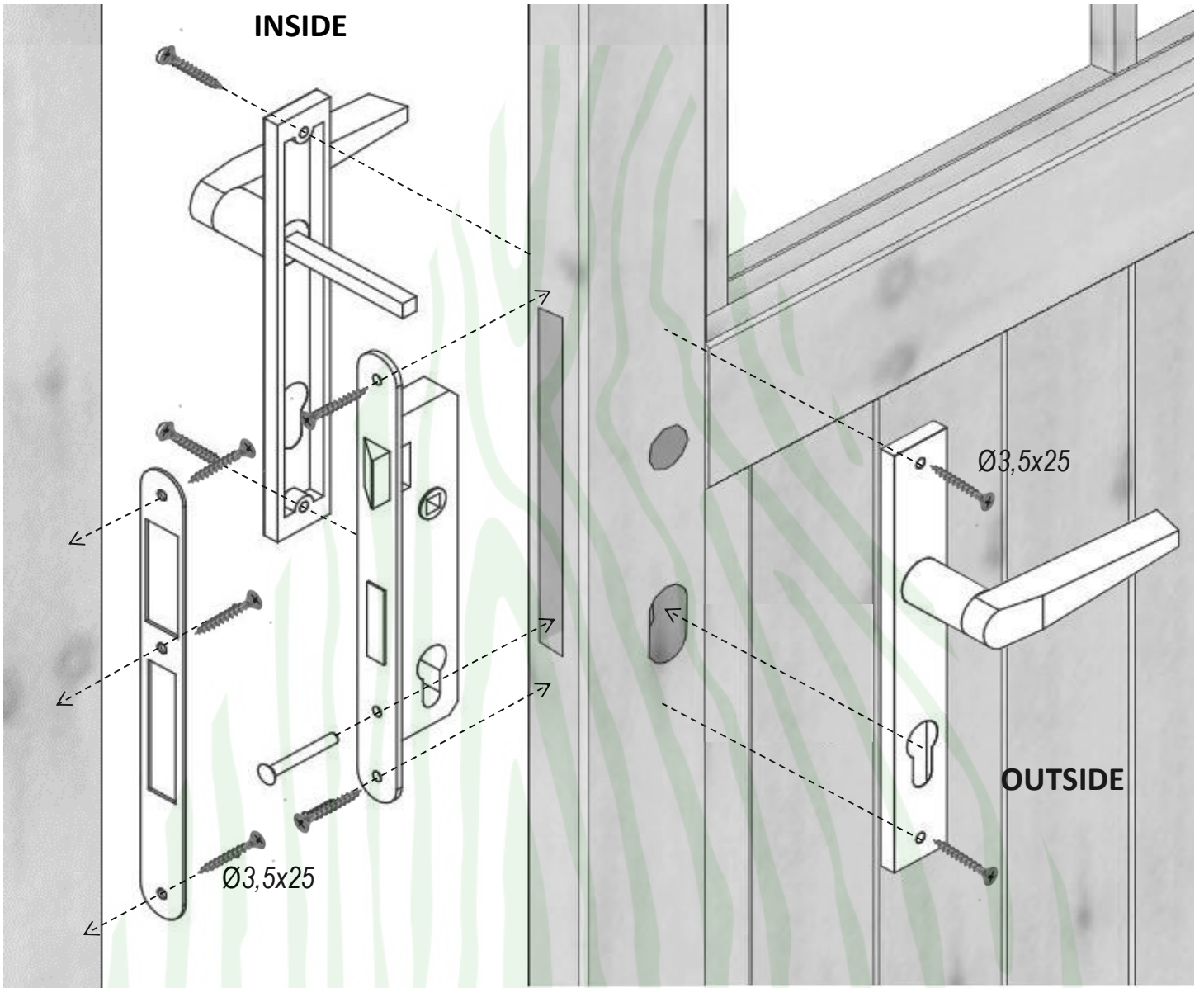

lock - change from the left to the right

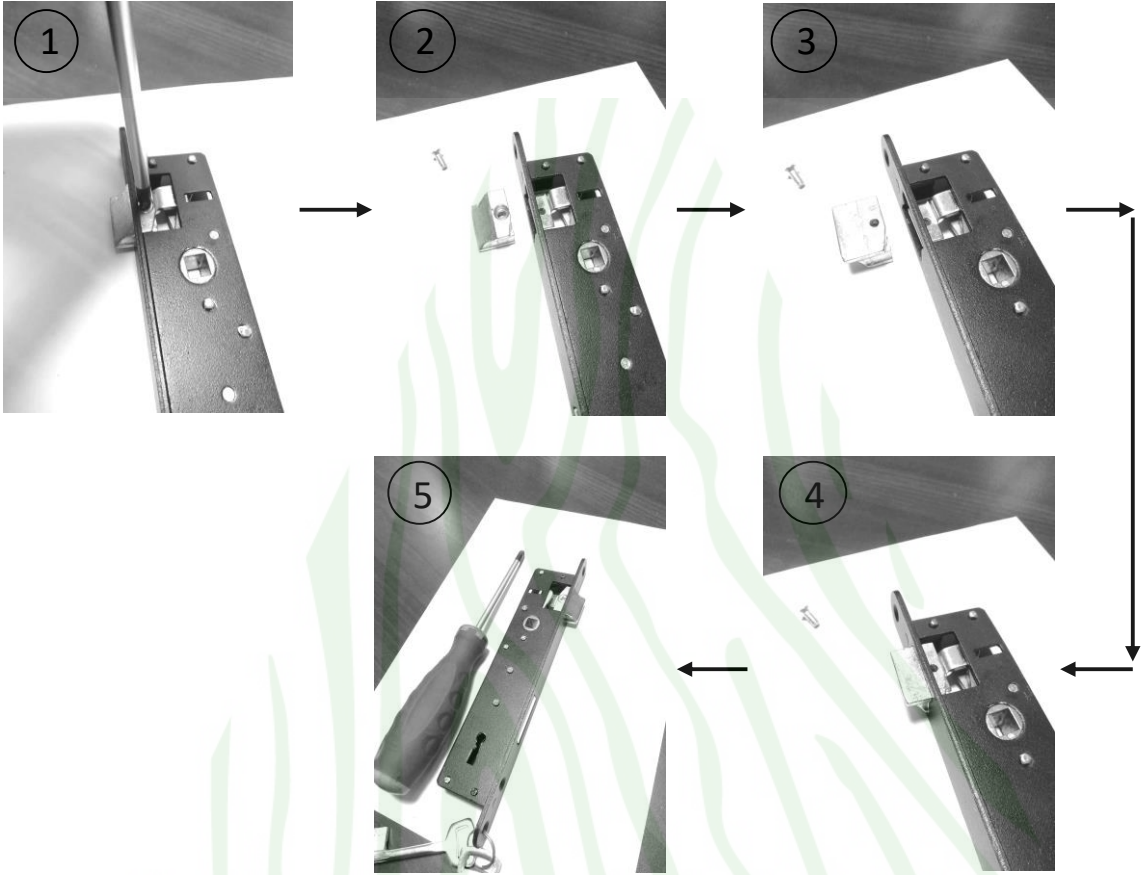

lock - change from the right to the left

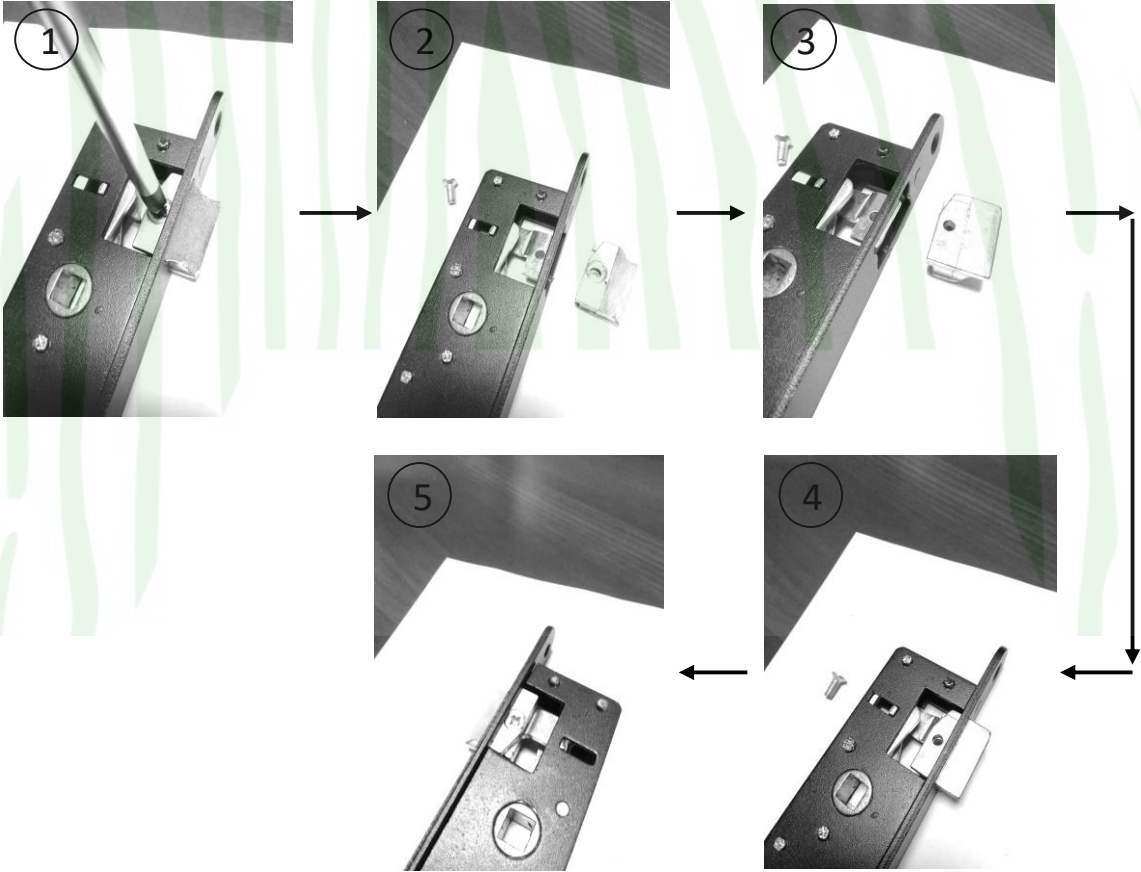

13

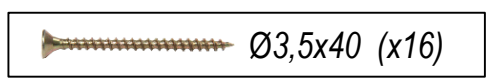
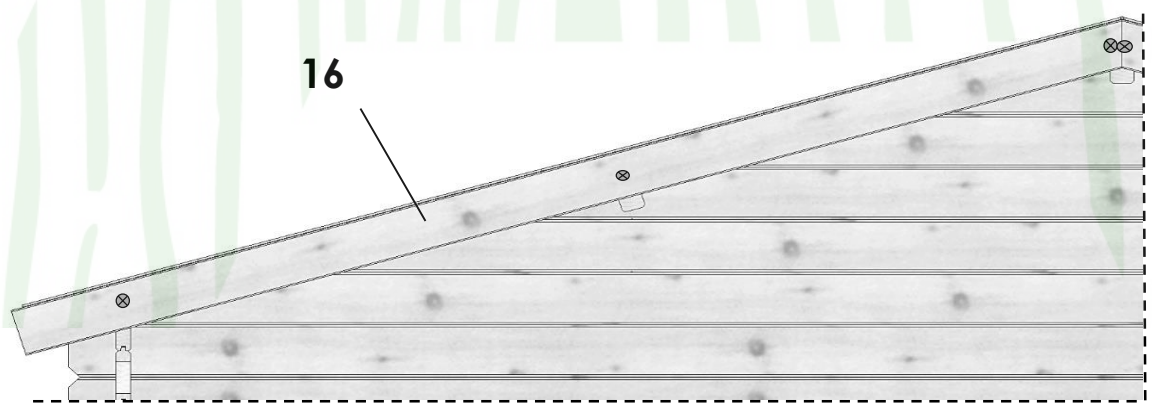
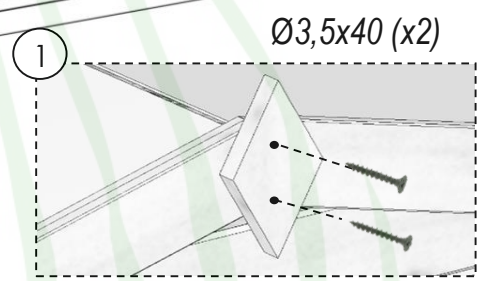
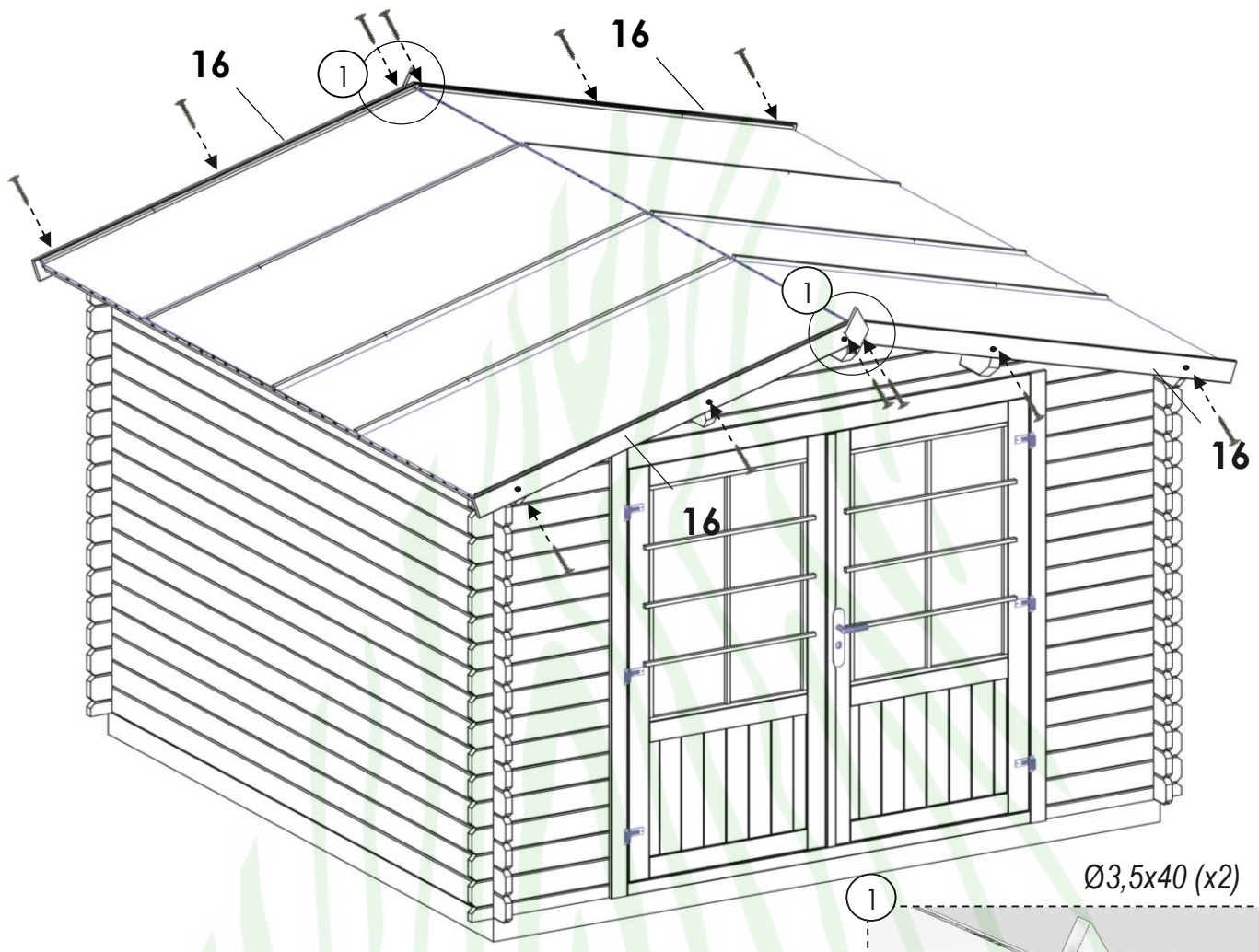

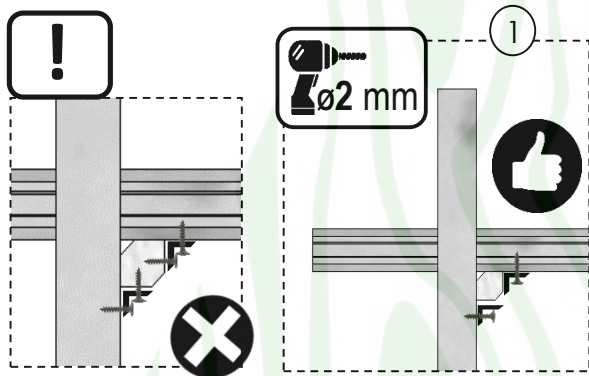
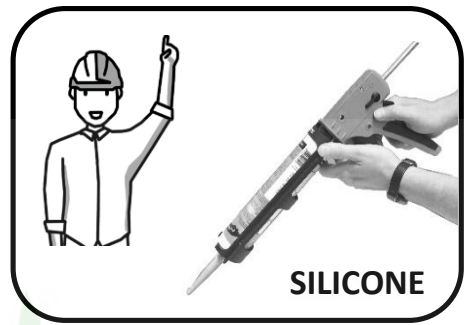
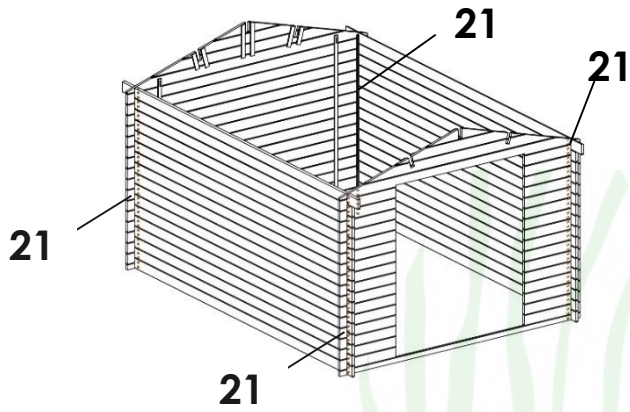

INSIDE Ø3,5x25 (x2)
L15x15 (x2)

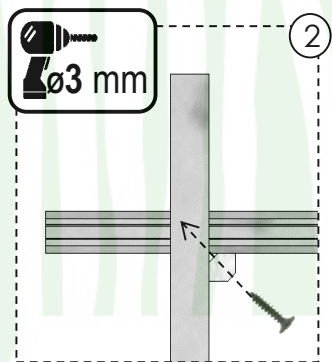

INSIDE Ø3,5x40

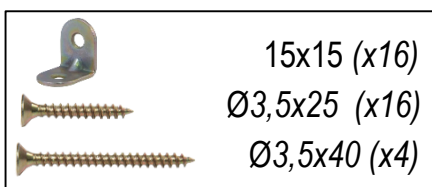
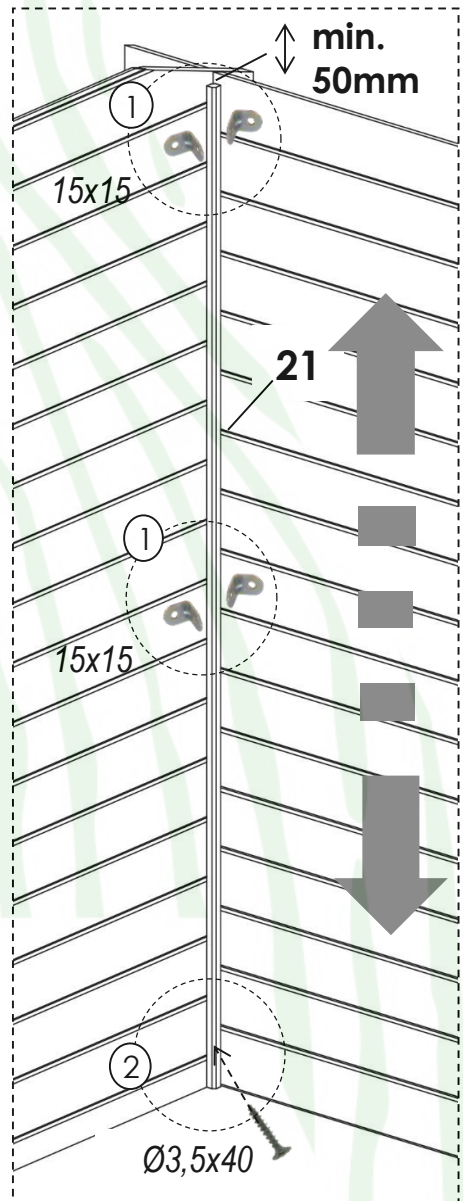

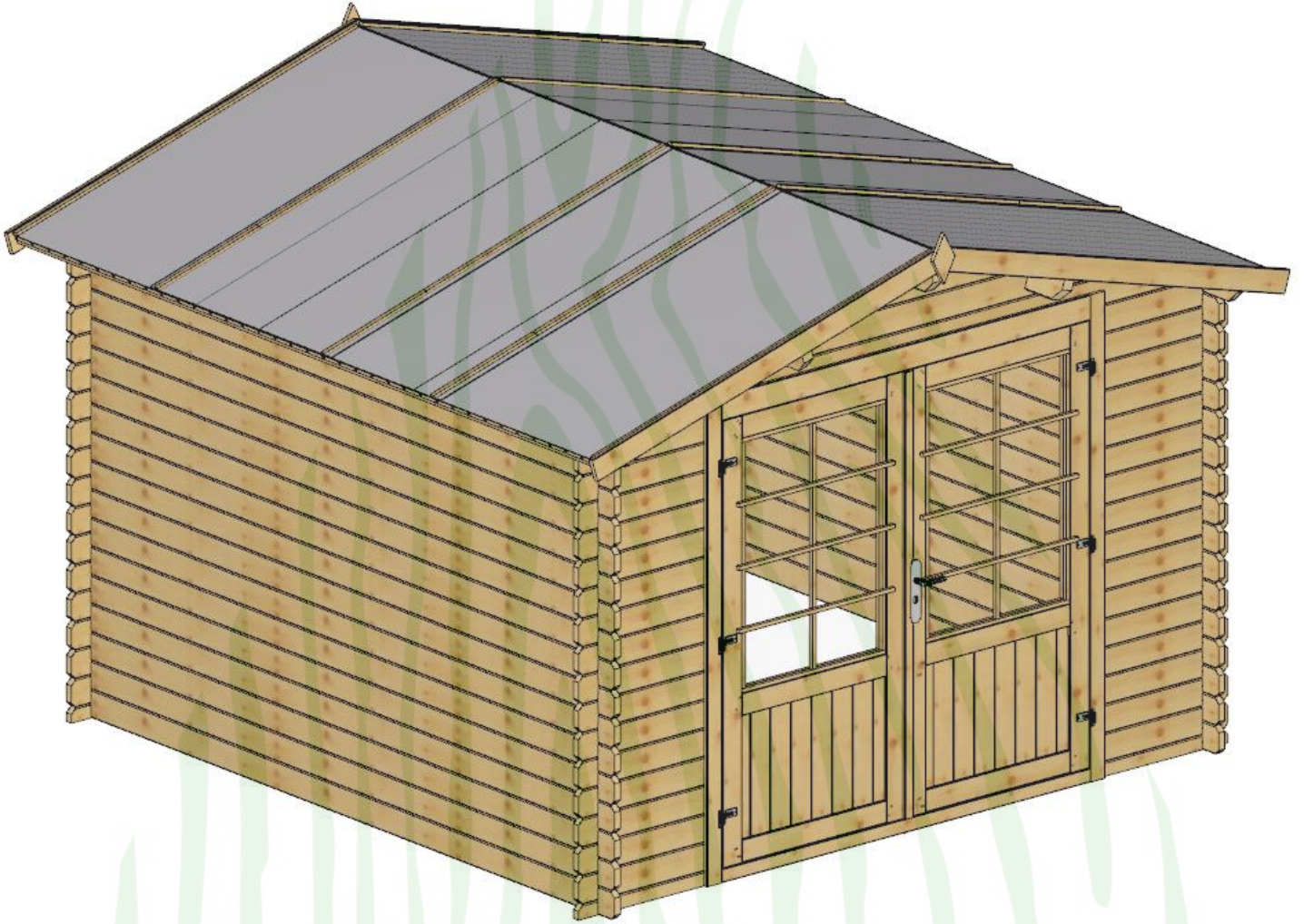

300x200cm 28mm



DOM141-1 300x200cm

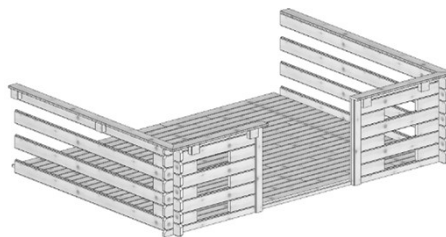

DOM142-1 300x200cm

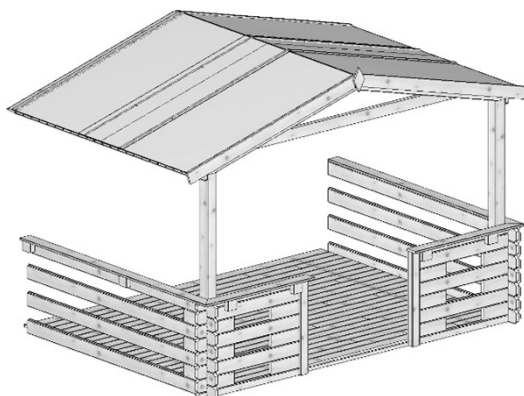

300x300cm 28mm

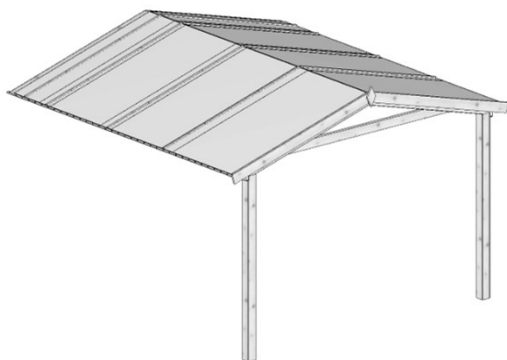

DOM32-2 300x300cm

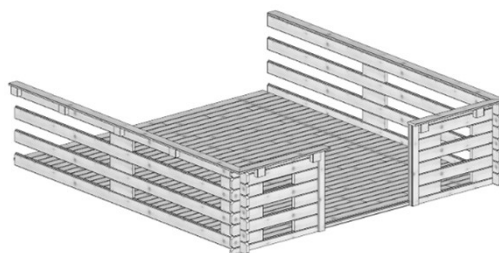

DOM395-1 300x300cm

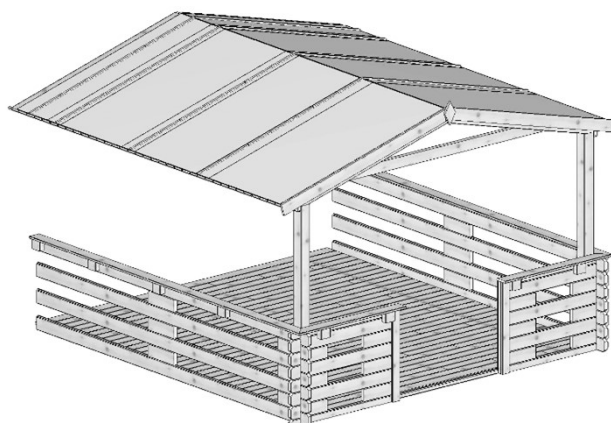

400x200cm 28mm

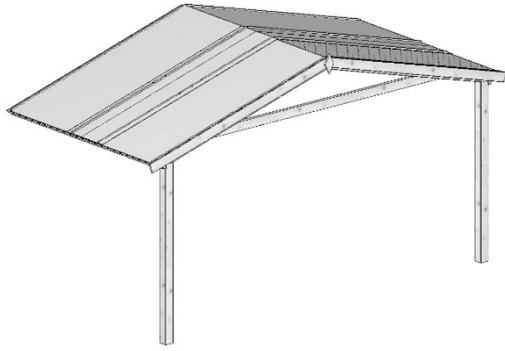

DOM 17-1 400x200cm

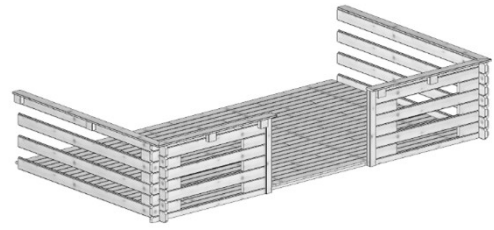

DOM18-1 400x200cm

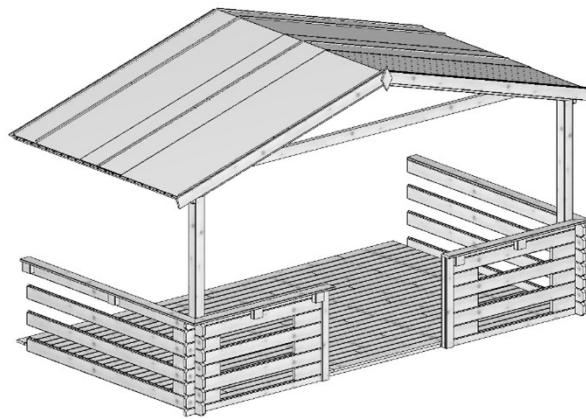

400x300cm 28mm

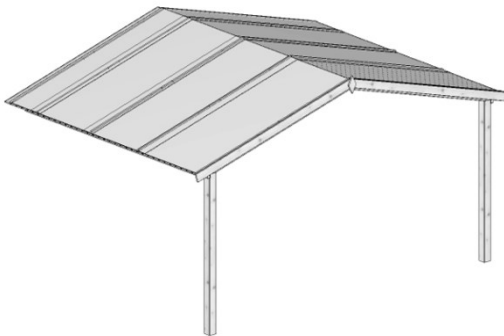

DOM392-1 400x300cm

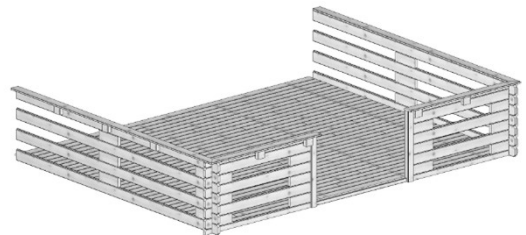

DOM393-1 400x300cm

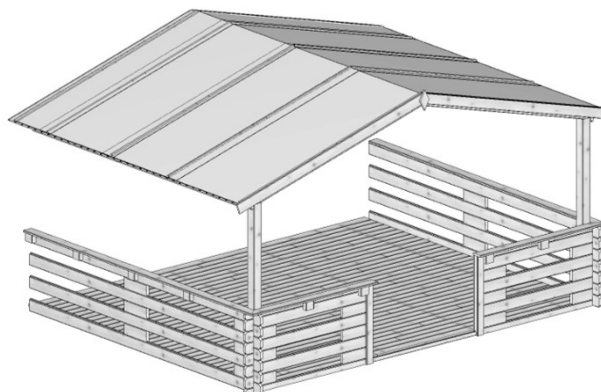

300x200cm 28mm

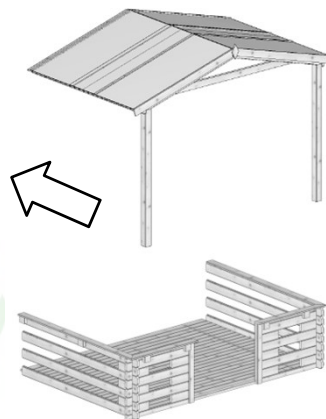
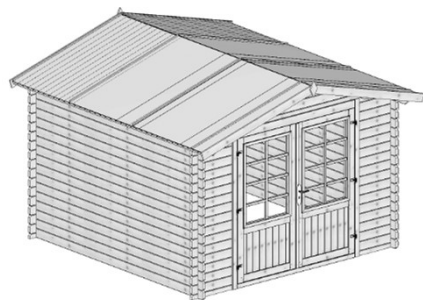

300x300cm 28mm

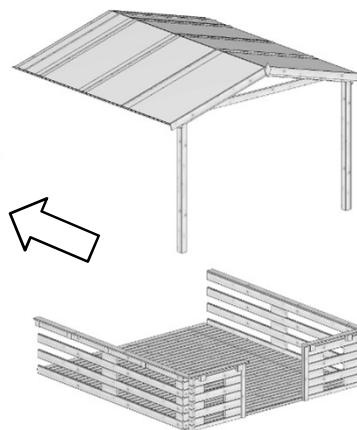
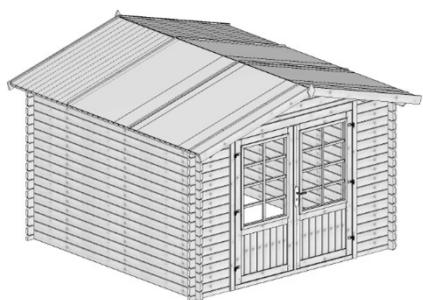



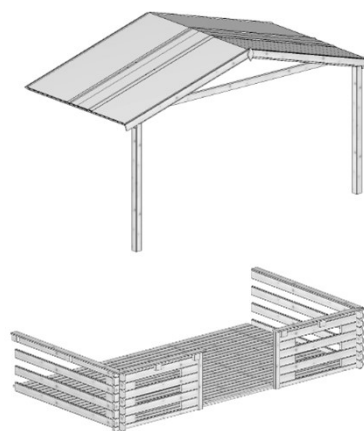
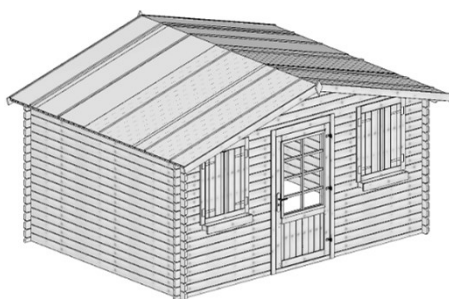



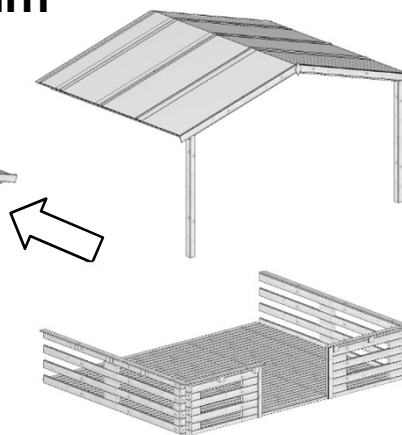
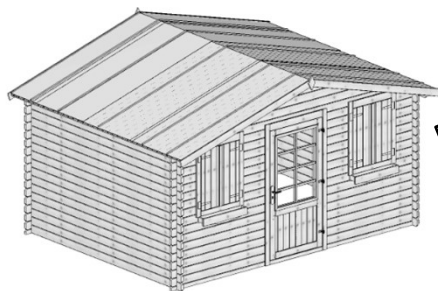















400x200cm 28mm



400x300cm 28mm























DOM141-1 300x200cm 28mm

nr.	element	[mm]	[mm]	[mm]	szt.	A	B
1		38	90	1489	2		
2		38	90	2340	1		
3		28	113	2000	2		
4		38	90	1962	3		
5		90	90	1908	2		
6		16	99	1640	46		
7		16	95	1680	2		
8		13	22	1150	18		
9		16	110	165	1		
10		3	1000	3500	2		
11		3	500	3500	1		
A		3,5 x 25			72		
B		3,5 x 40			16		
C		3,5 x 50			12		
D		4 x 30			104		
E		4 x 70			14		
F		5 x 100			3		
G		38 x 70			6		
H		6,0 x 140			1		
J		6,0 x 90			4		
K		2,0 x 40			276		
L		40x40x1,5			3		



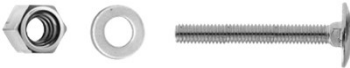





















DOM32-2 300x300cm 28mm

nr.	element	[mm]	[mm]	[mm]	szt.	A	B
1		38	90	1489	2		
2		38	90	2340	1		
3		28	113	3000	2		
4		38	90	2962	3		
5		90	90	1908	2		
6		16	99	1640	70		
7		16	95	1680	2		
8		13	22	1150	26		
9		16	110	165	1		
10		3	1000	3500	3		
11		3	500	3500	1		
A		3,5 x 25			104		
B		3,5 x 40			16		
C		3,5 x 50			12		
D		4 x 30			104		
E		4 x 70			14		
F		5 x 100			3		
G		38 x 70			6		
H		6,0 x 140			1		
J		6,0 x 90			4		
K		2,0 x 40			420		
L		40x40x1,5			3		







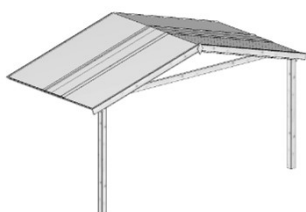

















DOM17-1 400x200cm 28mm

nr.	element	[mm]	[mm]	[mm]	szt.	A	B
1		38	90	2013	2		
2		38	90	3200	1		
3		28	113	2000	2		
4		38	90	1962	3		
5		90	90	1908	2		
6		16	99	2160	46		
7		16	95	2200	2		
8		13	22	1150	20		
9		16	110	165	1		
10		3	1000	4500	2		
11		3	500	4500	1		
A		3,5 x 25			80		
B		3,5 x 40			16		
C		3,5 x 50			12		
D		4 x 30			104		
E		4 x 70			14		
F		5 x 100			3		
G		38 x 70			6		
H		6,0 x 140			1		
J		6,0 x 90			4		
K		2,0 x 40			276		
L		40x40x1,5			3		



DOM392-1 400x300cm 28mm

nr.	element	[mm]	[mm]	[mm]	szt.	A	B
1		38	90	2013	2		
2		38	90	3200	1		
3		28	113	3000	2		
4		38	90	2962	3		
5		90	90	1908	2		
6		16	99	2160	70		
7		16	95	2200	2		
8		13	22	1150	26		
9		16	110	165	1		
10		3	1000	4500	3		
11		3	500	4500	1		
A		3,5 x 25			104		
B		3,5 x 40			16		
C		3,5 x 50			12		
D		4 x 30			104		
E		4 x 70			14		
F		5 x 100			3		
G		38 x 70			6		
H		6,0 x 140			1		
J		6,0 x 90			4		
K		2,0 x 40			420		
L		40x40x1,5			3		

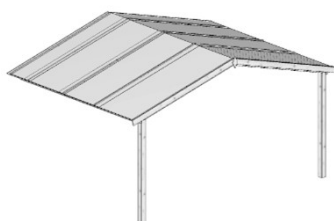

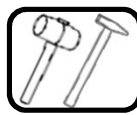

1

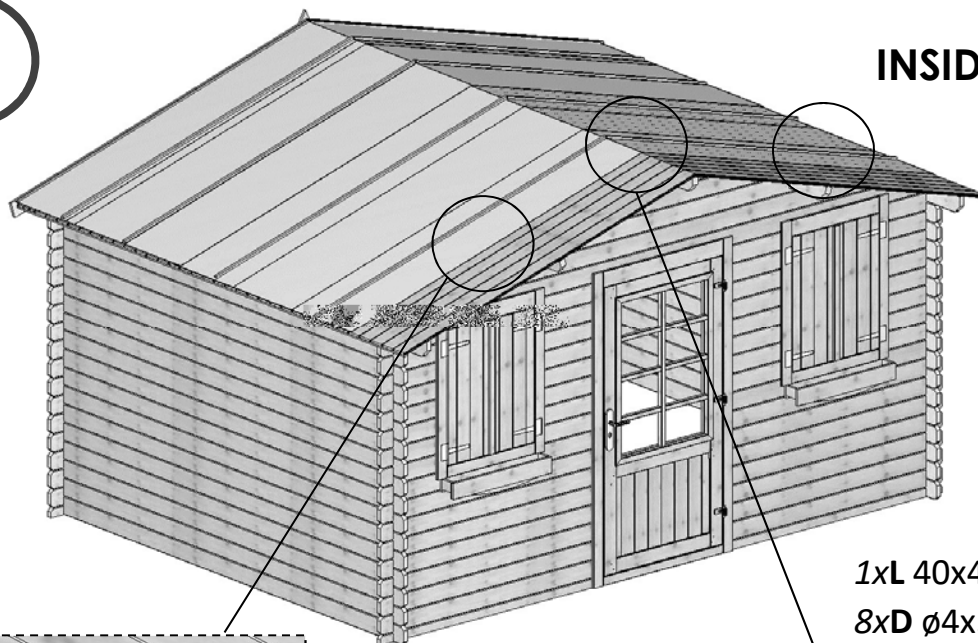

INSIDE

1xL 40x40x1,5
8xD ø4x30

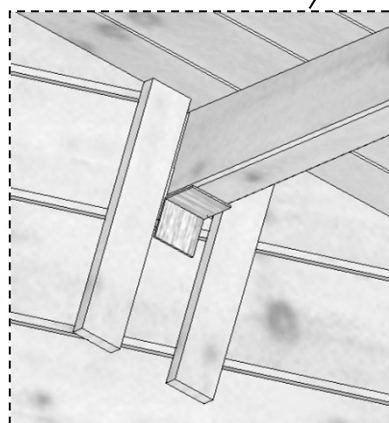

1xL 40x40x1,5
8xD ø4x30

INSIDE

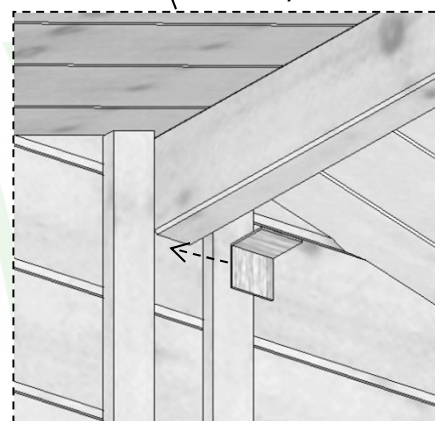

INSIDE

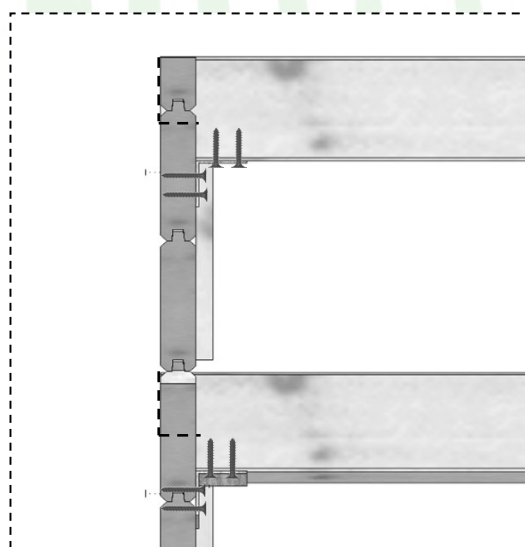

3xL 40x40x1,5

24xD ø4x30

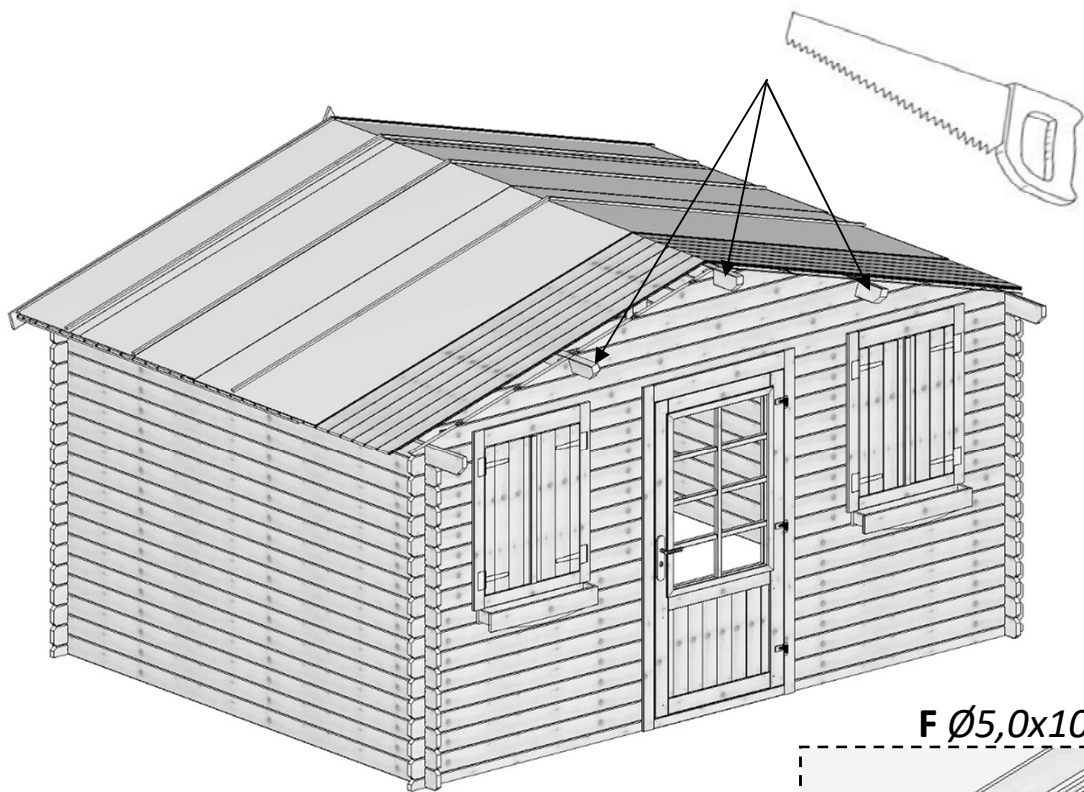

F Ø5,0x100

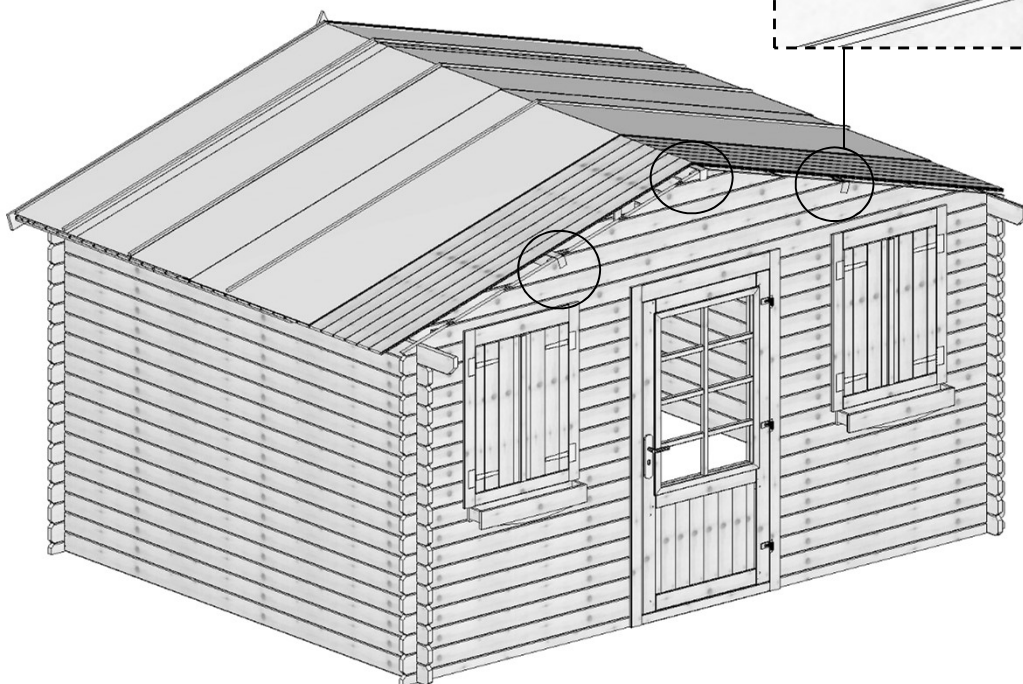
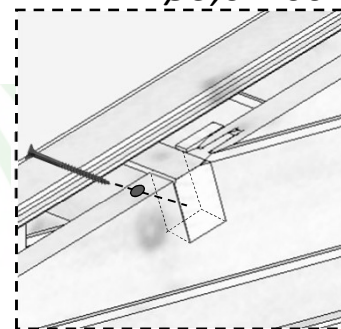

DOM141-1 DOM32-2

2

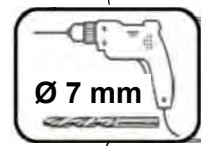
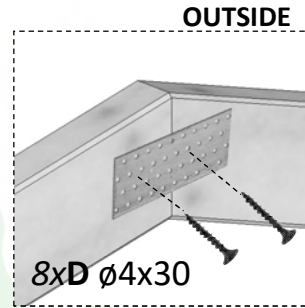
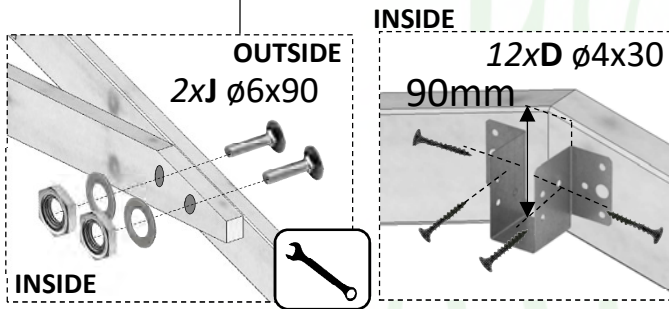
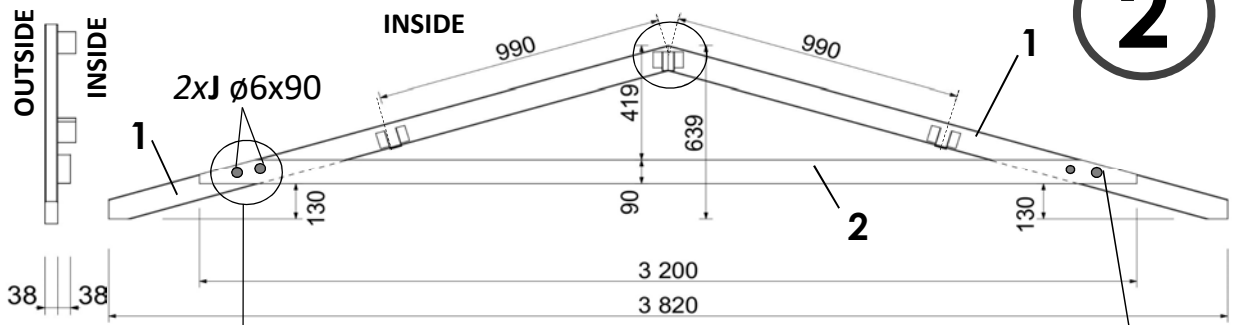

DOM17-1 DOM392-1

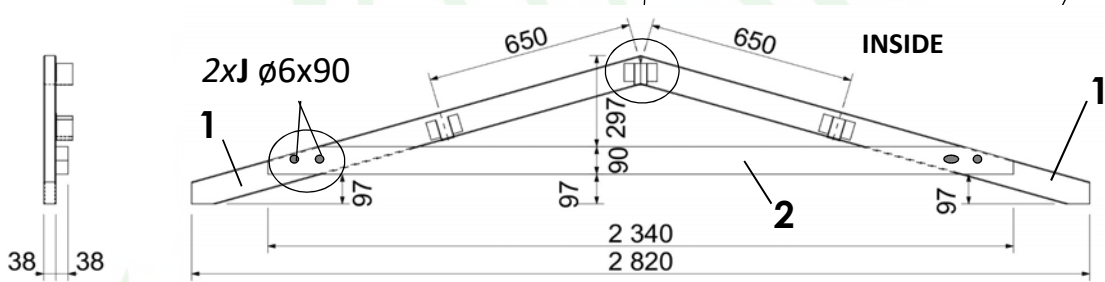

3

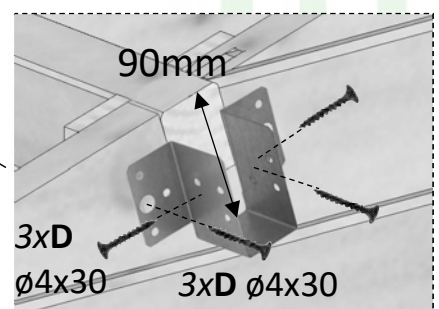
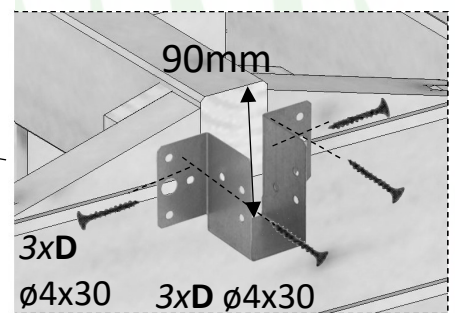
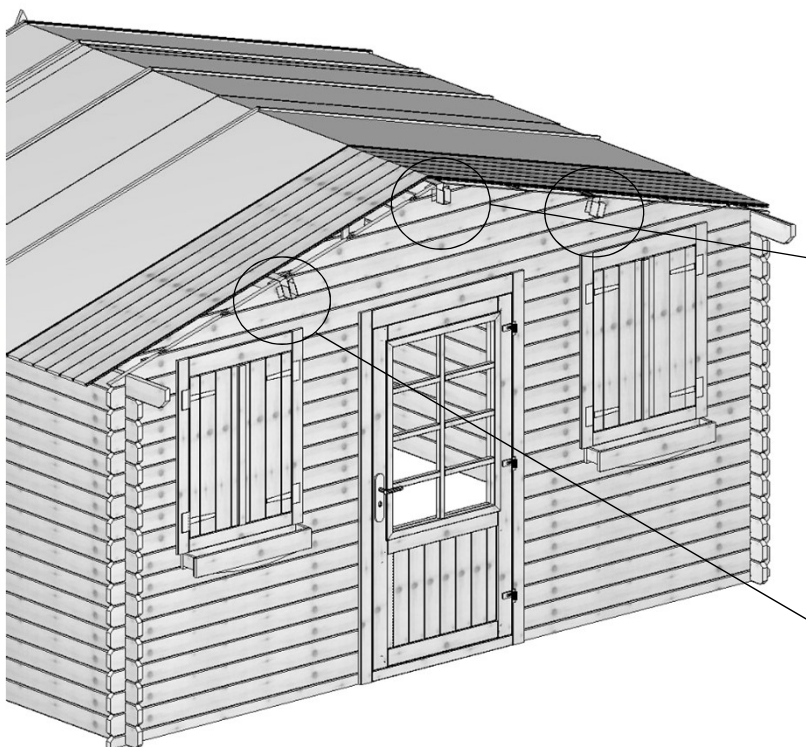

4

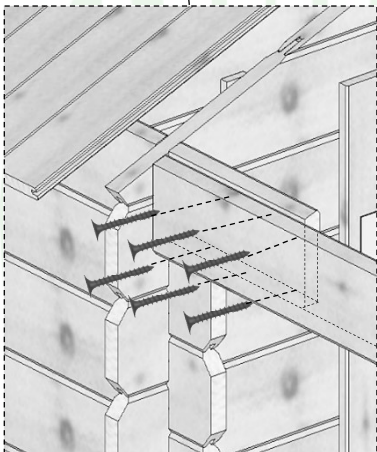
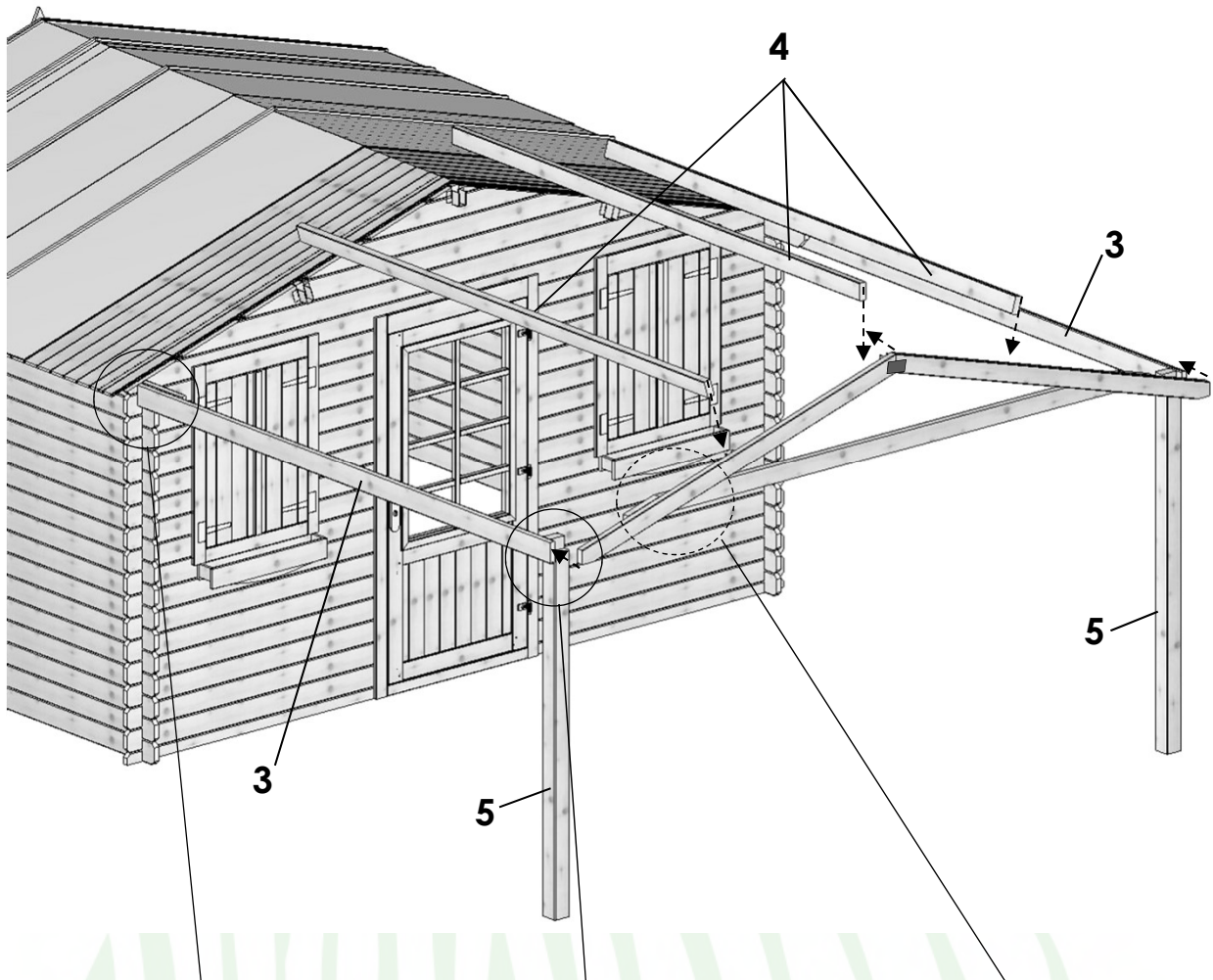

6xC $\phi 3,5 \times 50$

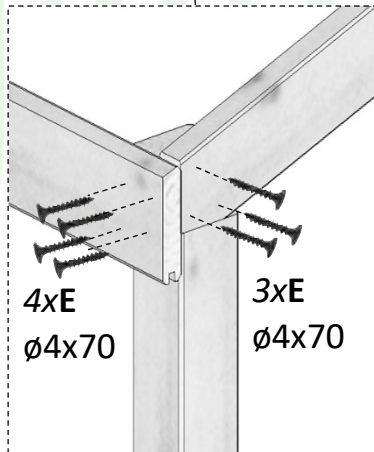

4xE
 $\phi 4 \times 70$

3xE
 $\phi 4 \times 70$

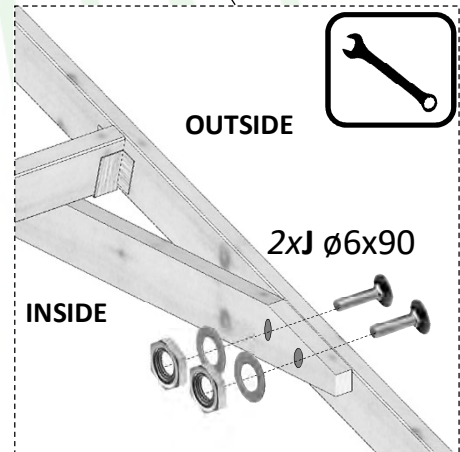

OUTSIDE

2xJ $\phi 6 \times 90$

INSIDE

5

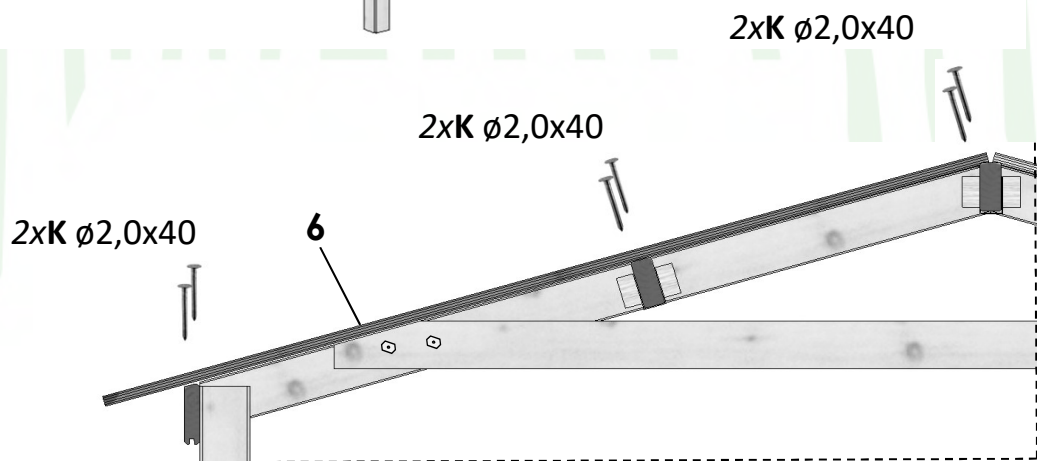
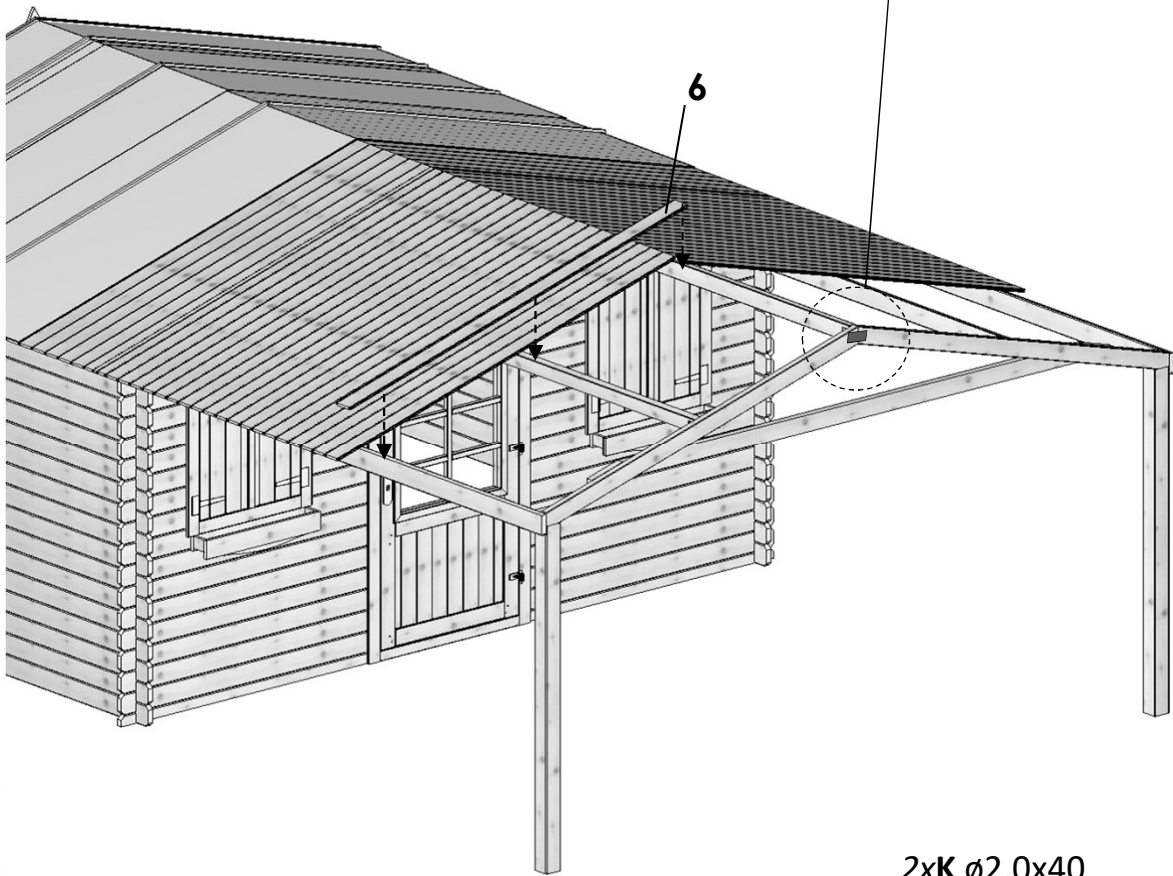
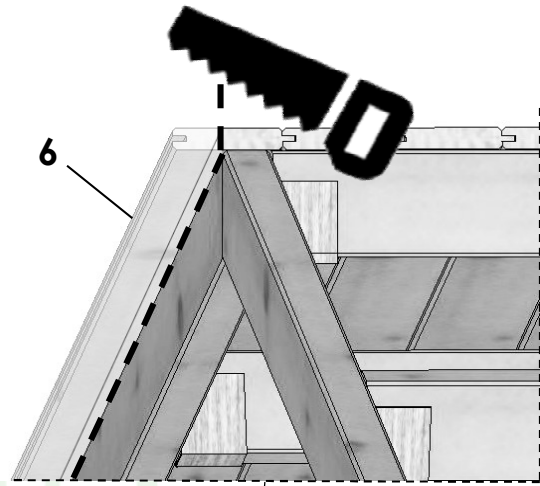

6

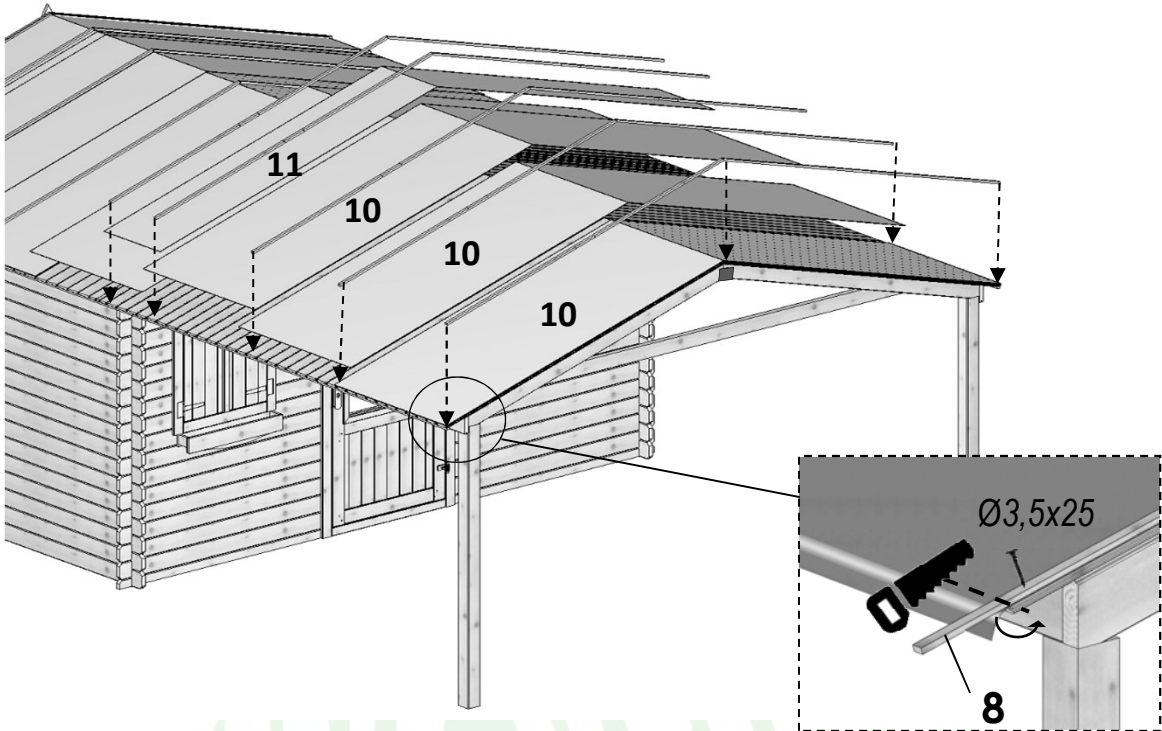
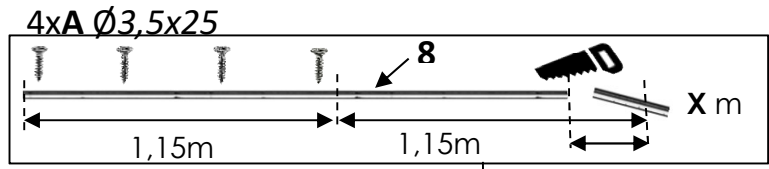



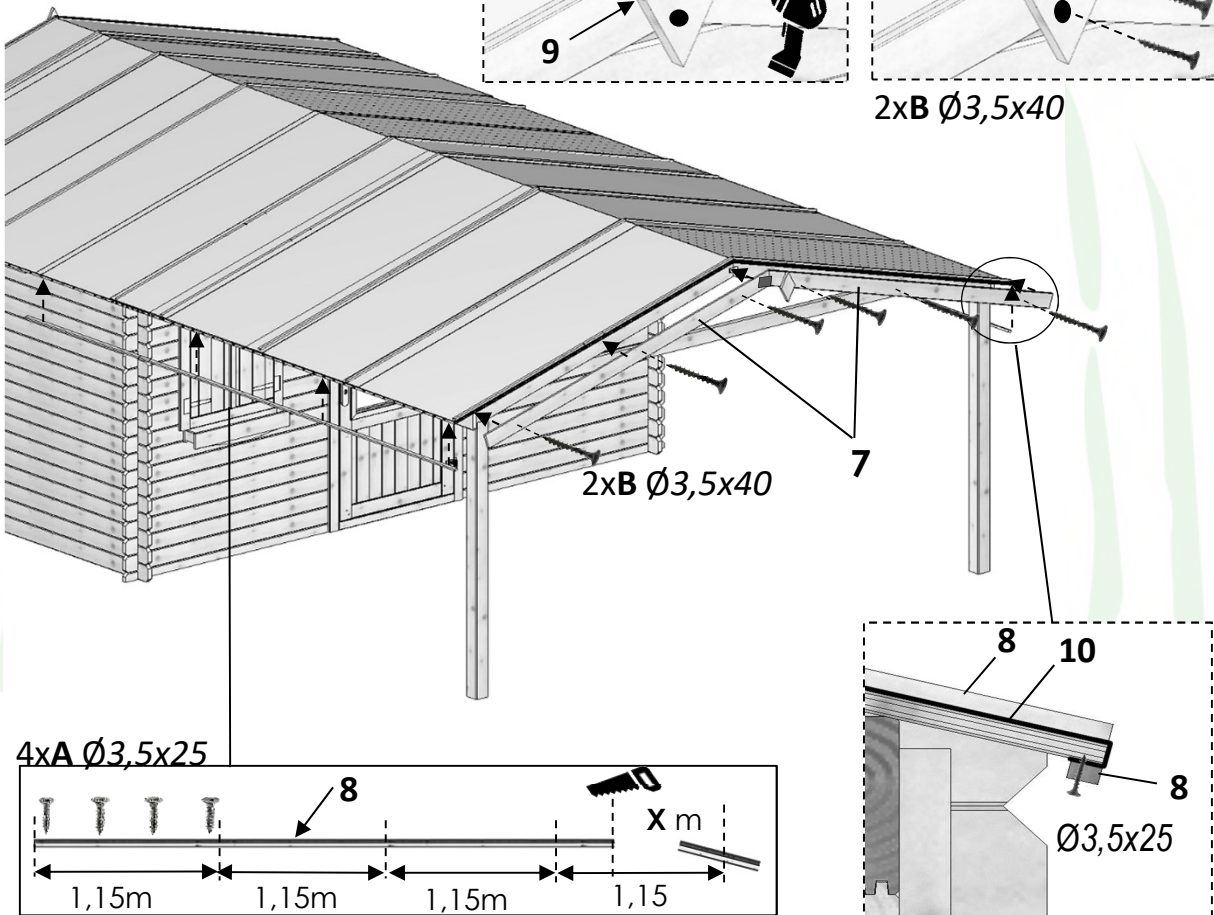
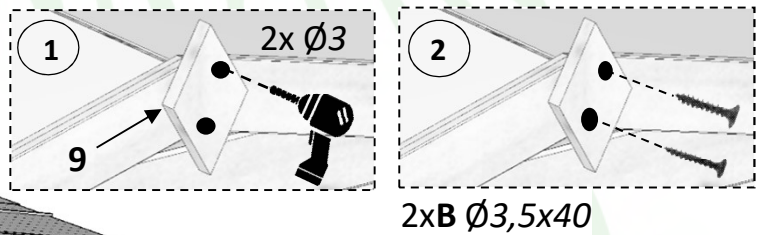

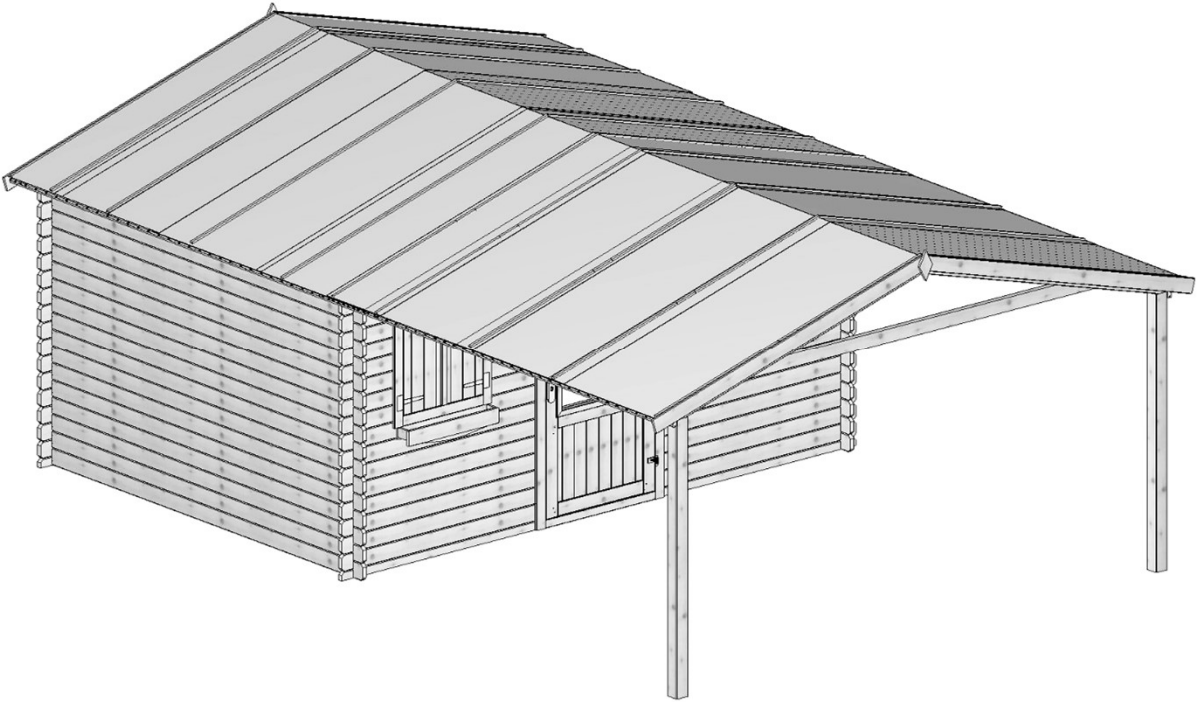













7











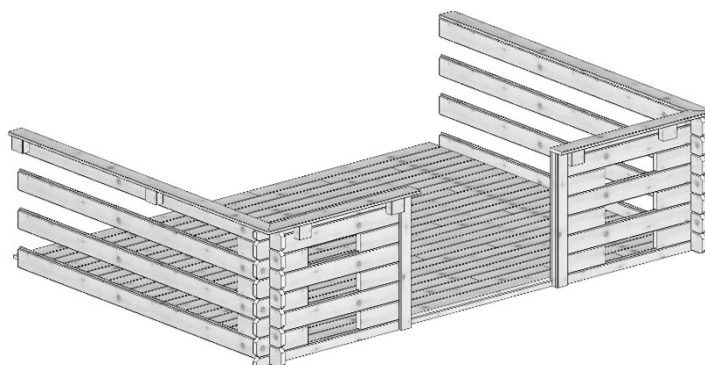











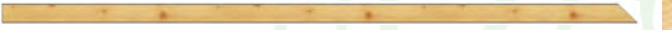

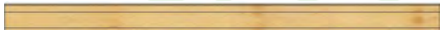
DOM142-1 300x200cm 28mm

nr.	element	[mm]	[mm]	[mm]	szt.	A	B
1		28	121	2118	6		
2		28	64	1000	2		
3		28	121	350	12		
4		28	121	300	6		
5		28	121	1000	6		
6		28	57	1000	2		
7		28	113	2118	2		
8		19	95	2097	2		
9		19	95	1030	2		
10		67 61	70	790	2		
11		38 45	90	90	8		
12		16	40	986	1		
13		28	58	2400	10		
14		19	99	2400	28		
A		3,5 x 50			52		
B		3,5 x 25			24		
C		2,0 x 40			414		
D					2		







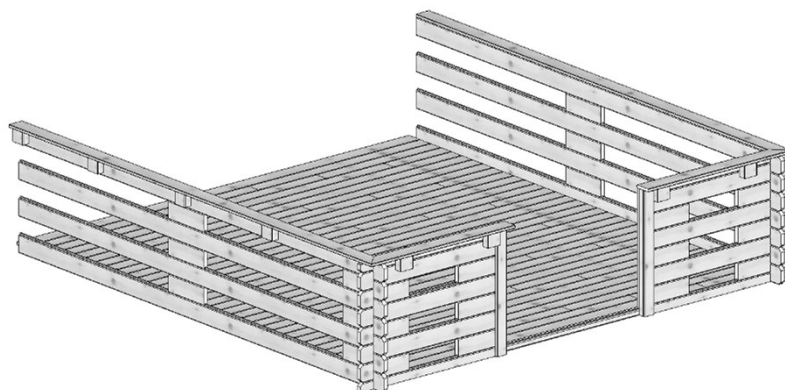













DOM395-1 300x300cm 28mm

nr.	element	[mm]	[mm]	[mm]	szt.	A	B
1		28	121	3118	6		
2		28	64	1000	2		
3		28	121	350	12		
4		28	121	300	12		
5		28	121	1000	6		
6		28	57	1000	2		
7		28	113	3118	2		
8		19	95	3097	2		
9		19	95	1030	2		
10		67 61	70	790	2		
11		38 45	90	90	12		
12		16	40	986	1		
13		28	58	2400	12		
14		19	99	2400	42		
A		3,5 x 50			68		
B		3,5 x 25			24		
C		2,0 x 41			612		
D					2		







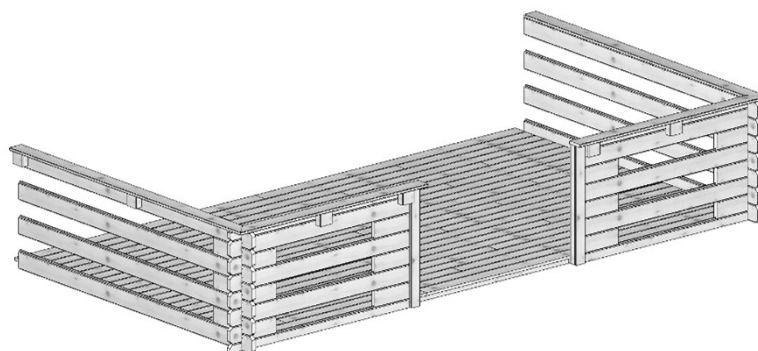









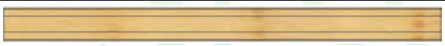

DOM18-1 400x200cm 28mm

nr.	element	[mm]	[mm]	[mm]	szt.	A	B
1		28	121	2118	6		
2		28	64	1400	2		
3		28	121	350	12		
4		28	121	300	6		
5		28	121	1400	6		
6		28	57	1400	2		
7		28	113	2118	2		
8		19	95	2097	2		
9		19	95	1430	2		
10		67 61	70	790	2		
11		38 45	90	90	8		
12		16	40	1186	1		
13		28	58	2400	16		
14		19	99	2400	39		
A		3,5 x 50			52		
B		3,5 x 25			24		
C		2,0 x 40			616		
D		60 x 60 x 40			2		

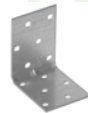

DOM393-1 400x300cm 28mm

nr.	element	[mm]	[mm]	[mm]	szt.	A	B
1		28	121	3118	6		
2		28	64	1400	2		
3		28	121	350	12		
4		28	121	300	12		
5		28	121	1400	6		
6		28	57	1400	2		
7		28	113	3118	2		
8		19	95	3097	2		
9		19	95	1430	2		
10		67 61	70	790	2		
11		38 45	90	90	12		
12		16	40	1186	1		
13		28	58	2400	18		
14		19	99	2400	56		
A		3,5 x 50			68		
B		3,5 x 25			24		
C		2,0 x 41			912		
D		60 x 60 x 40			2		

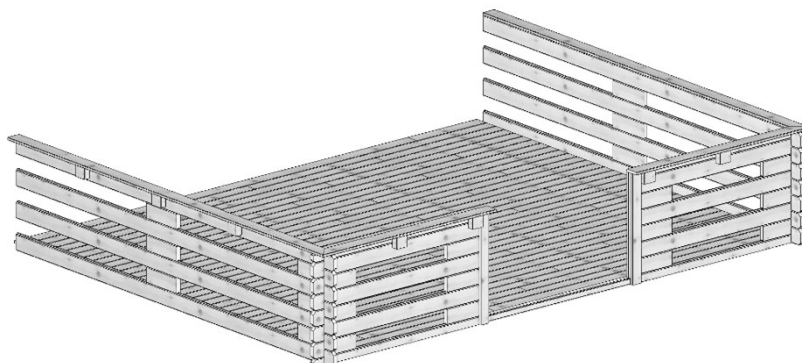

DOM142-1 DOM395-1 DOM18-1 DOM393-1

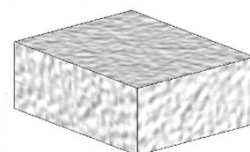
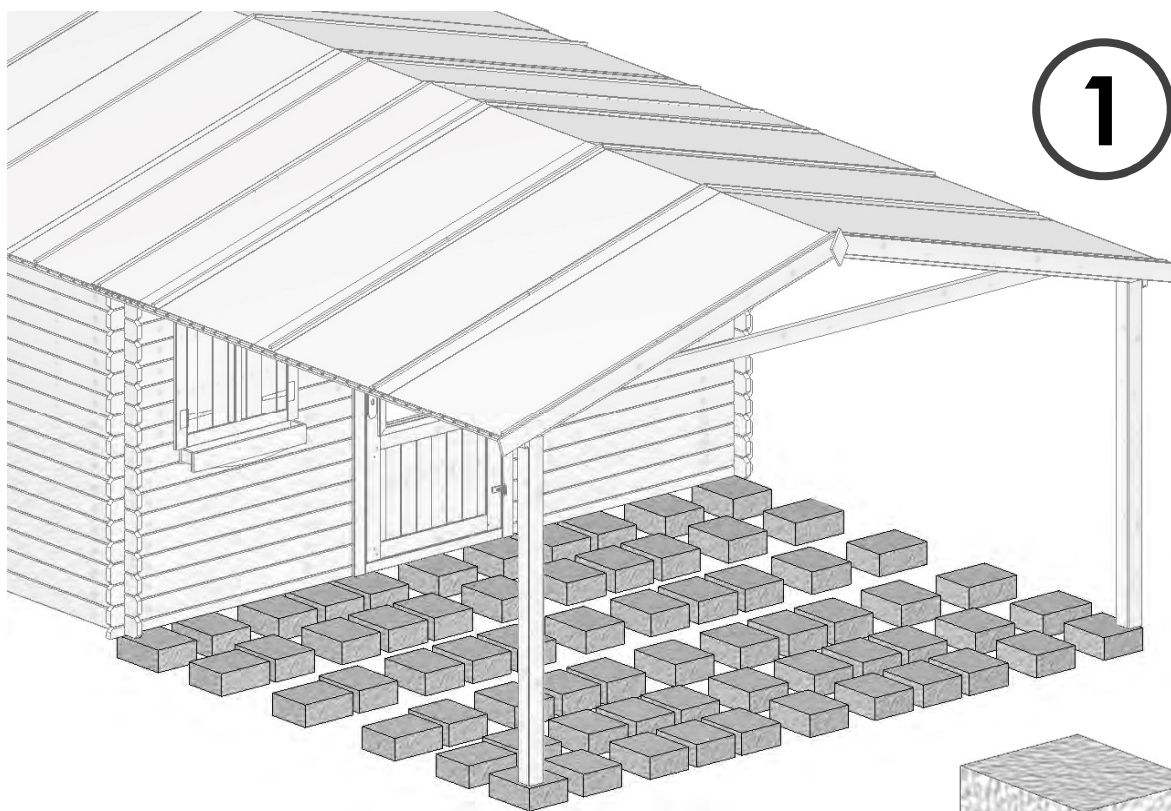

DOM142-1 300x200cm 28mm

32x 300x240x120

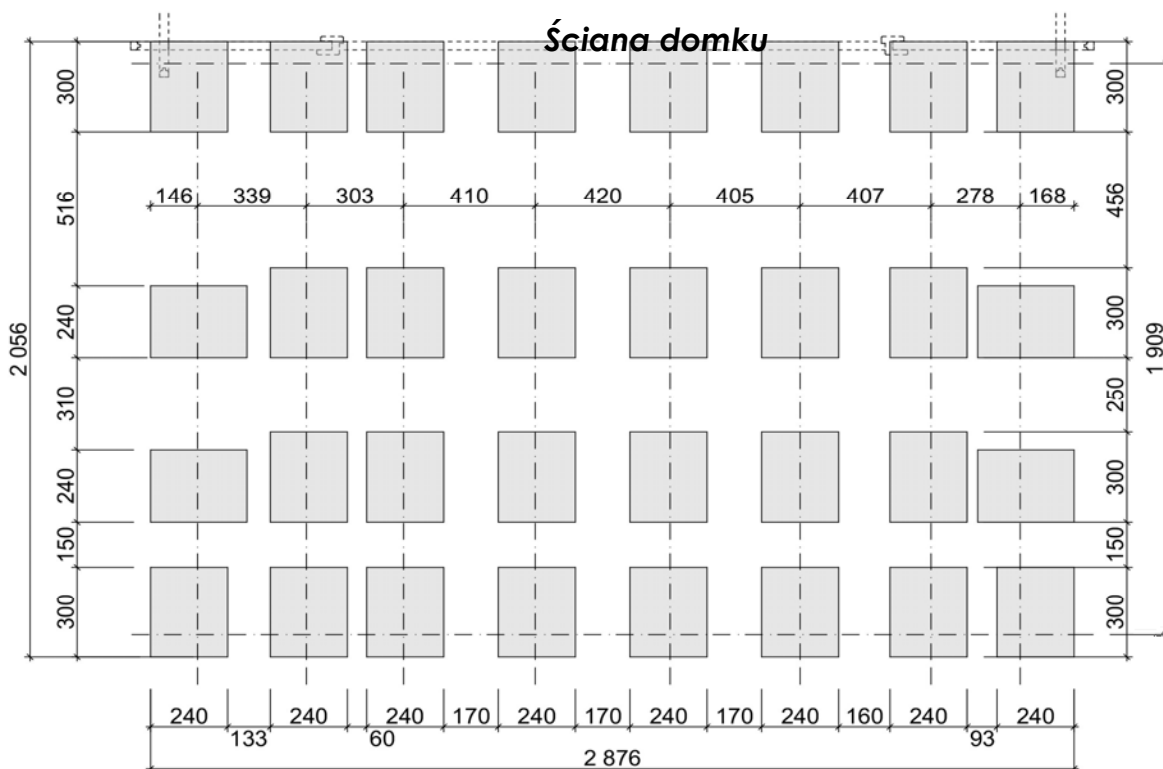

DOM 395-1 300x300cm 28mm

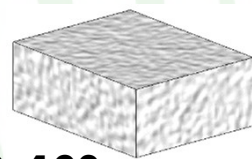
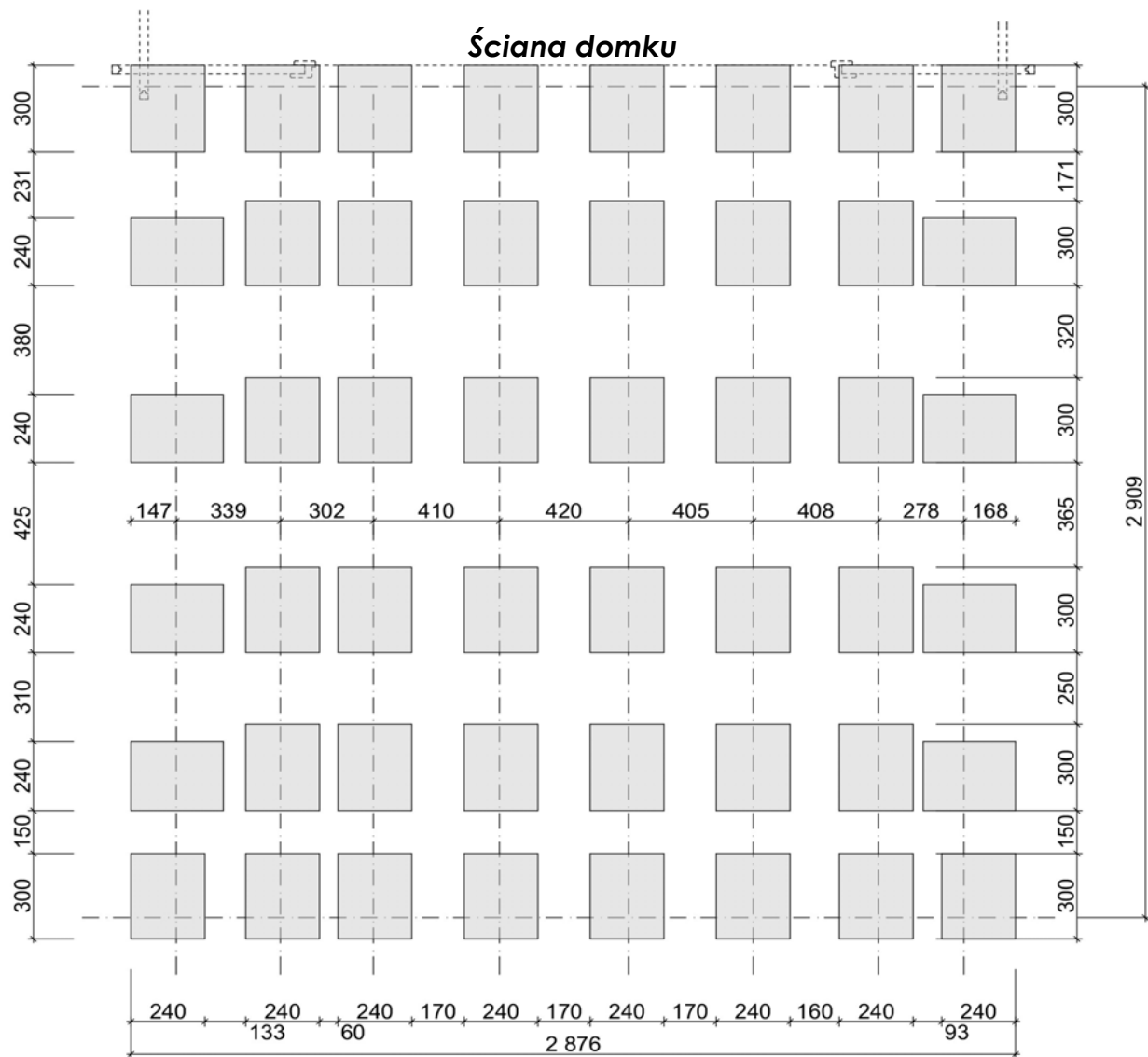

48x **300x240x120**

DOM18-1 400x200cm 28mm

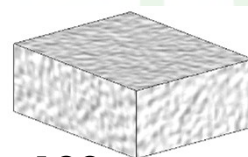
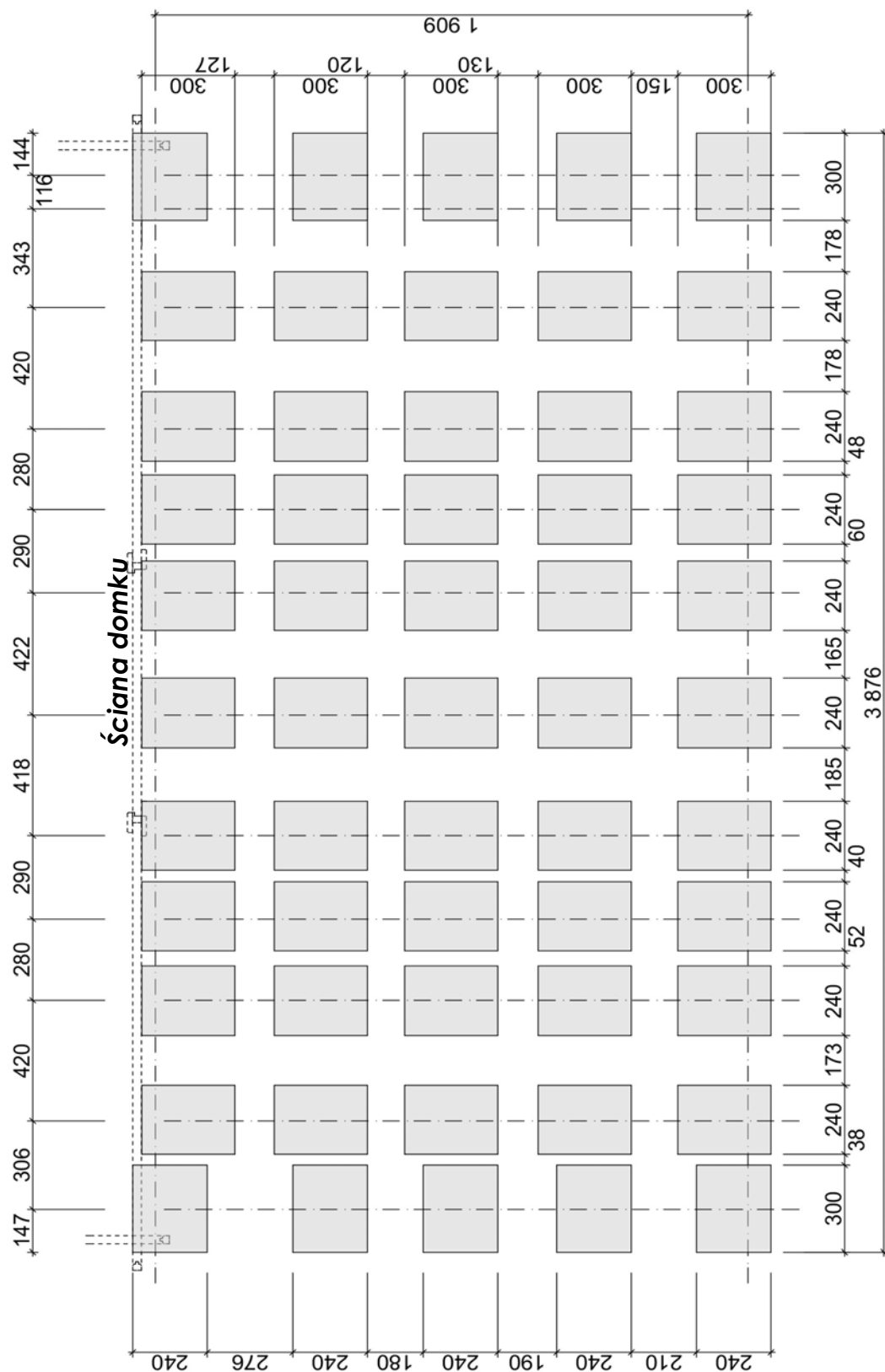

55x **300x240x120**

DOM393-1 400x300cm 28mm

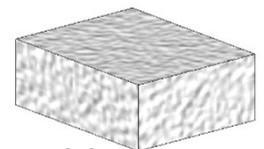
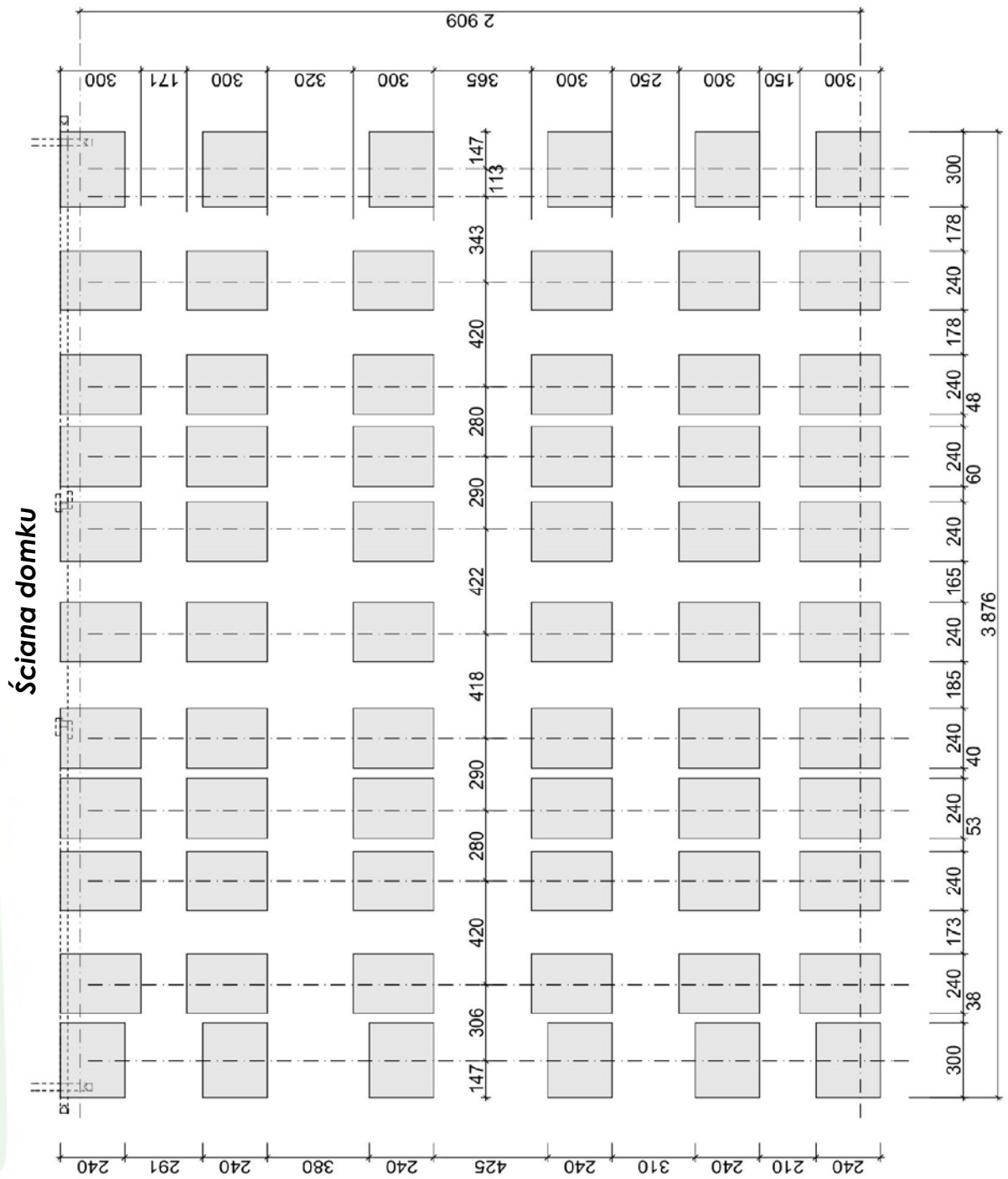

66x **300x240x120**

2xA Ø3,5x50

2

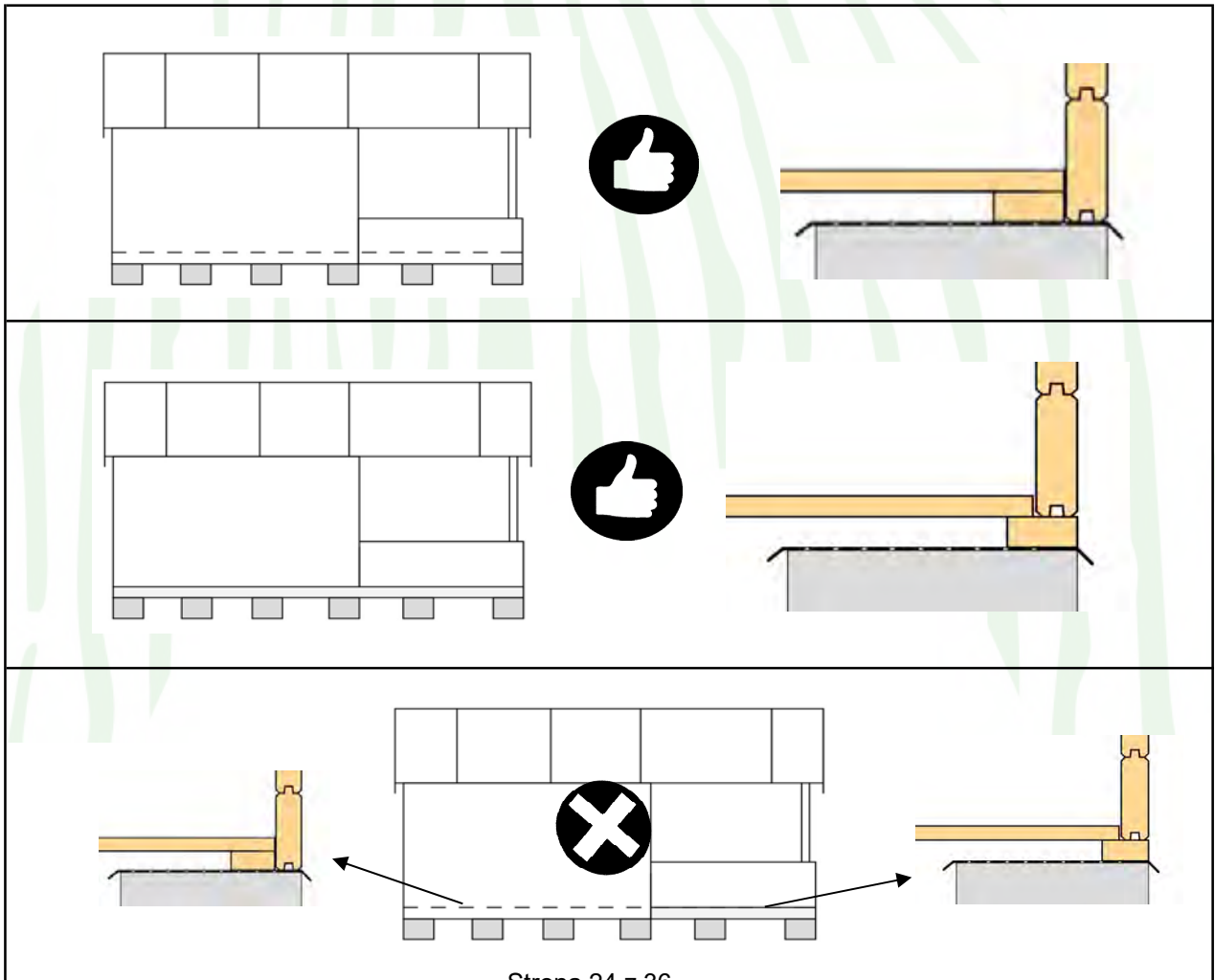
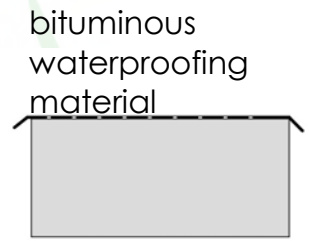
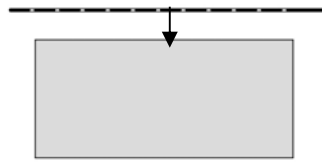
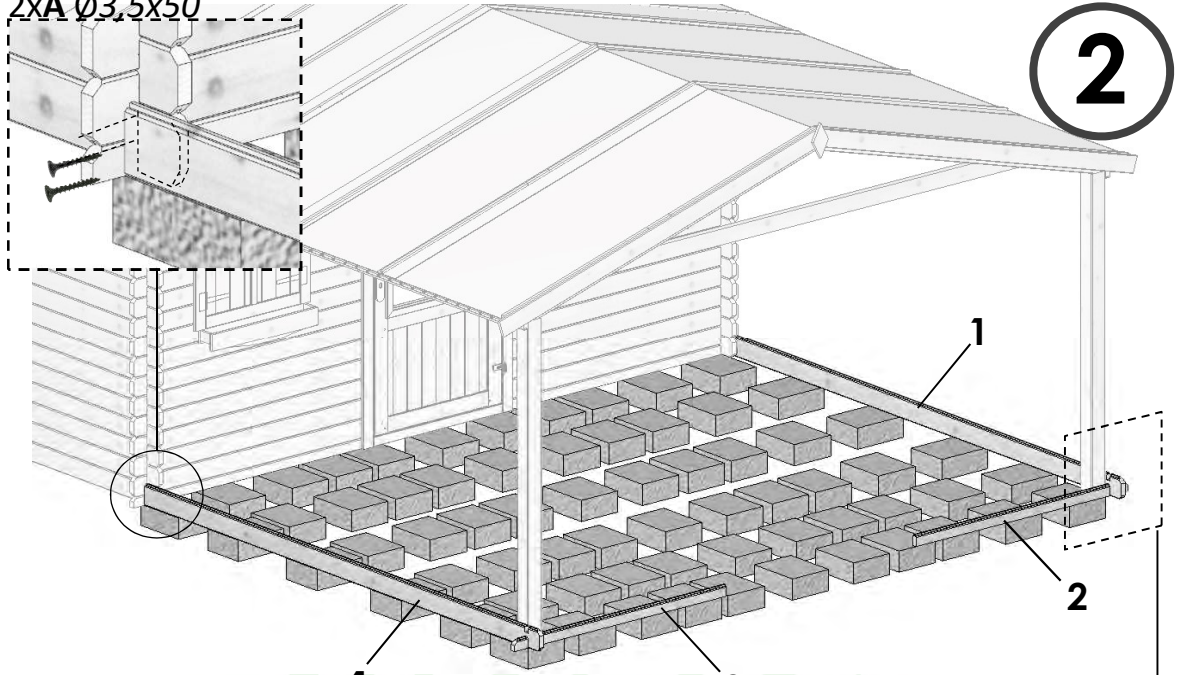

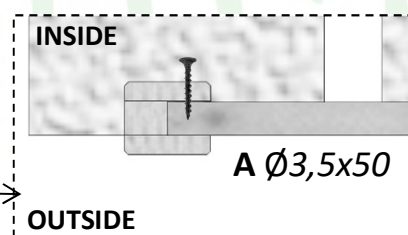
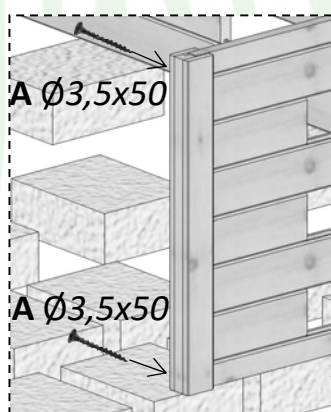
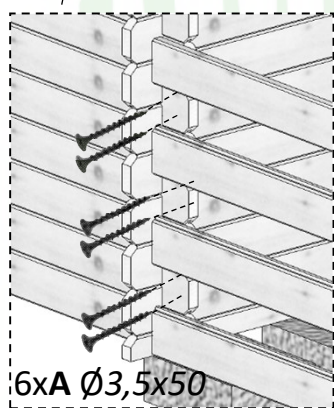
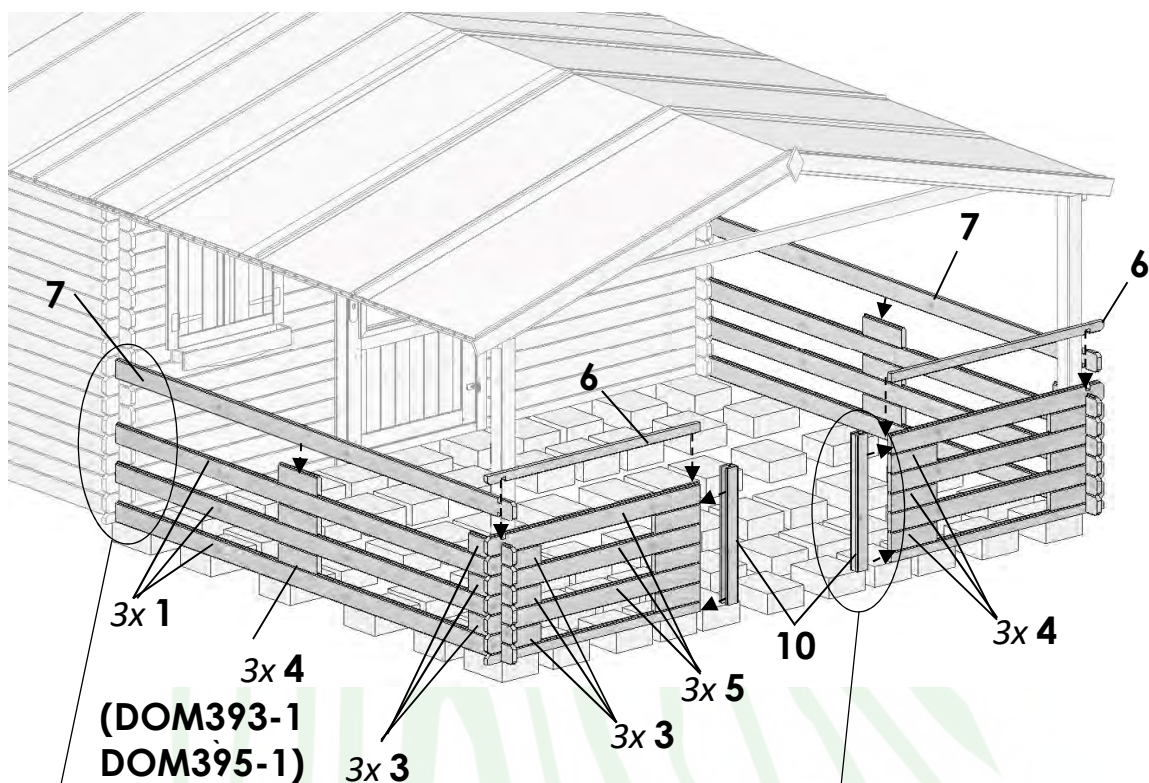

4

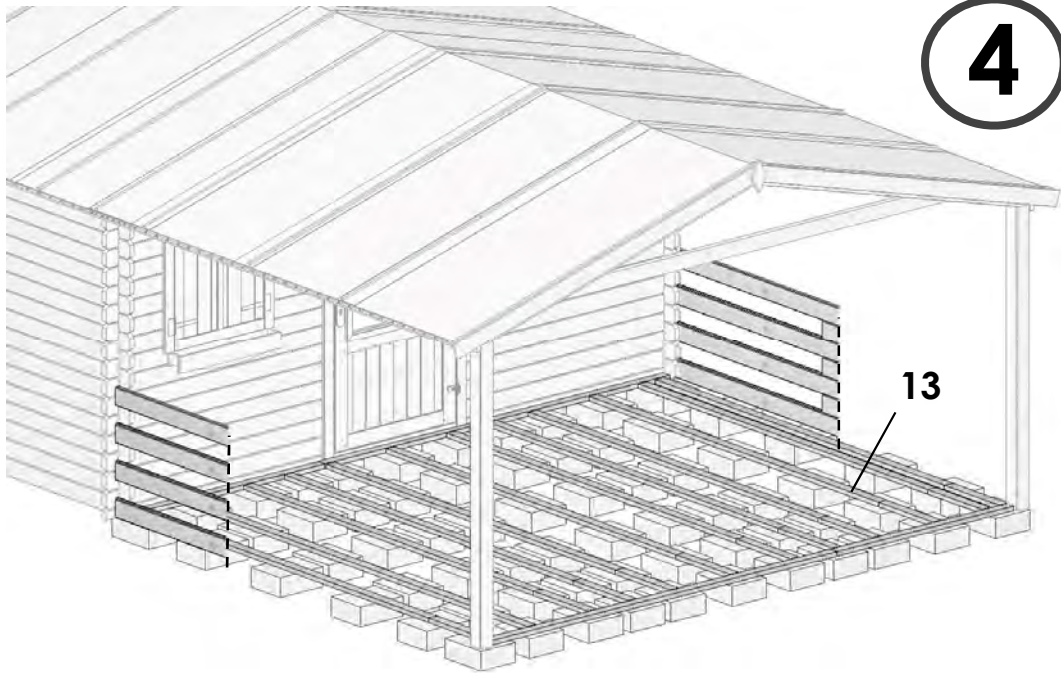

DOM142-1 300x200cm 28mm

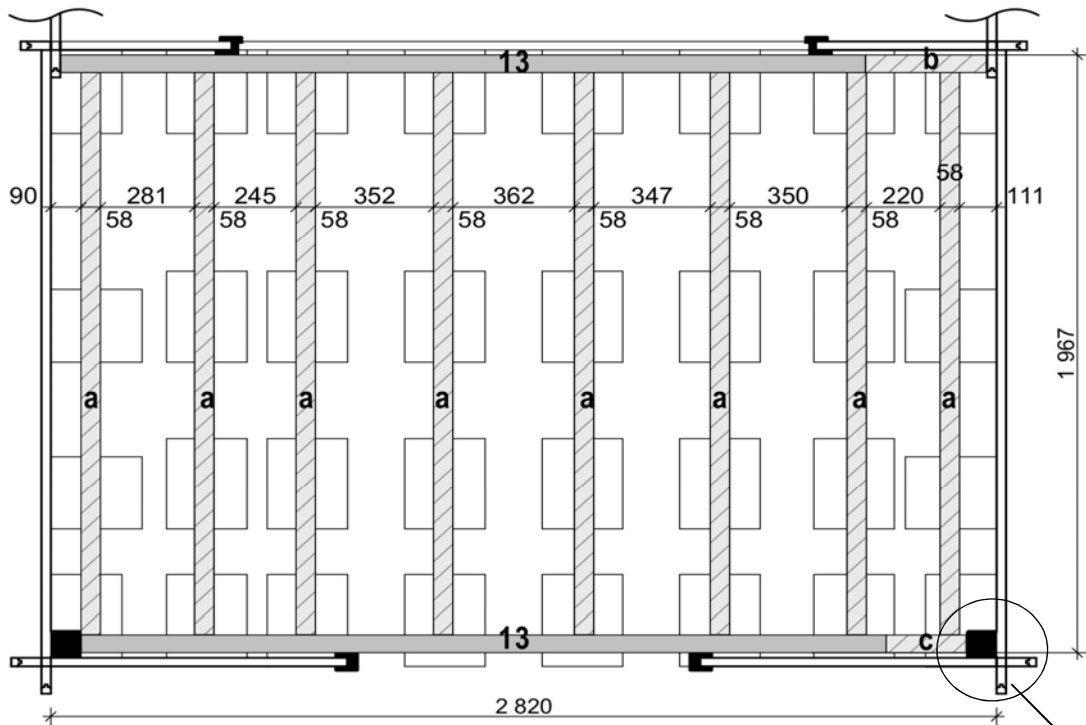

- 2x **13** Legar 28x58x**2400** mm
- 8x **a** Legar 28x58x**1850** mm
- 1x **b** Legar 28x58x**360** mm
- 1x **c** Legar 28x58x**238** mm

DOM395-1 300x300cm 28mm

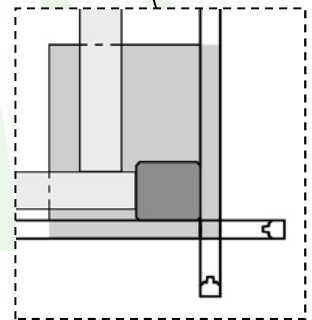
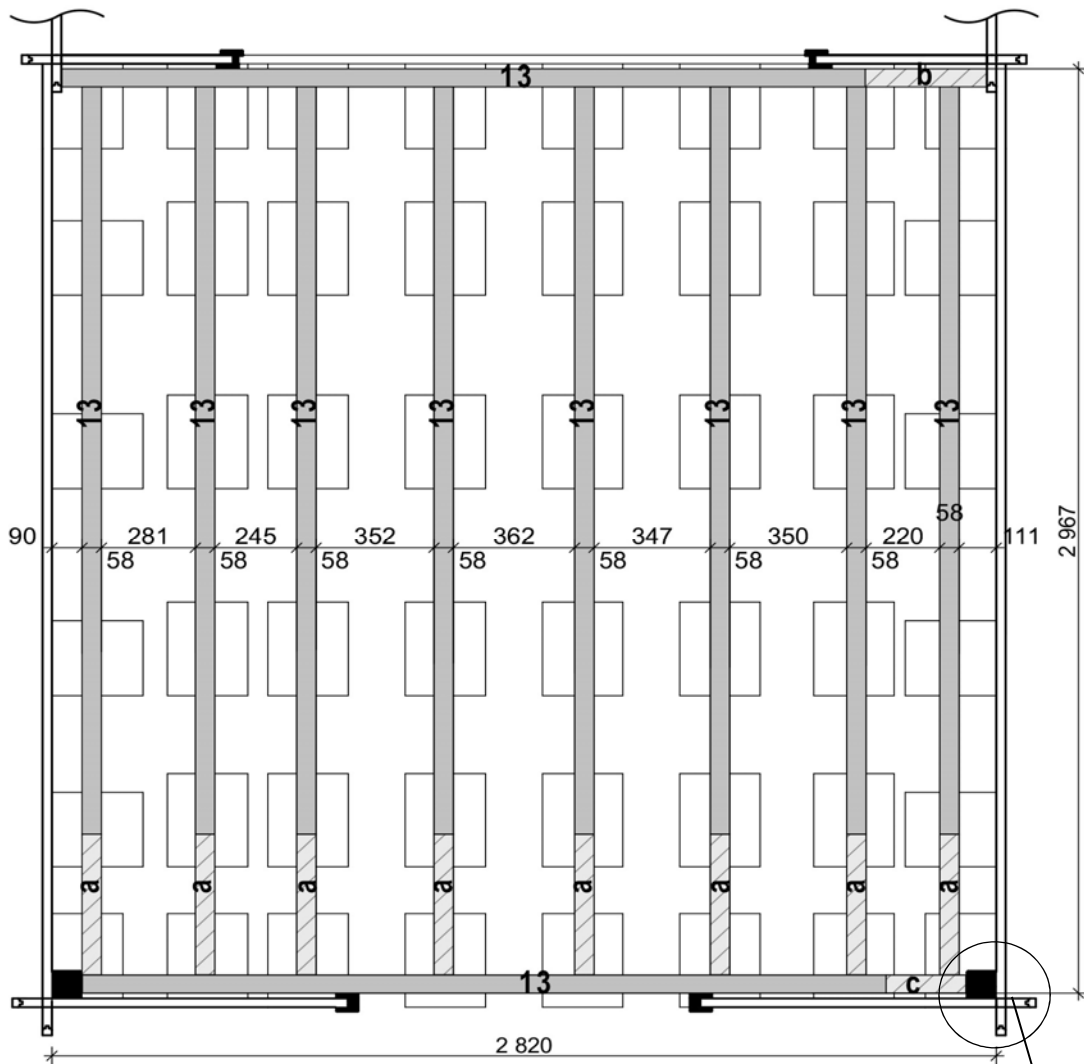

10x **13** Legar 28x58x2400 mm

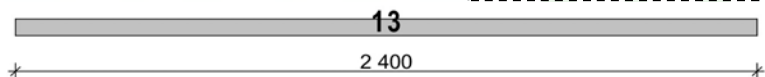

8x **a** Legar 28x58x450 mm

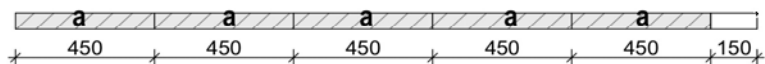

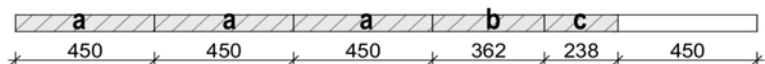

1x **b** Legar 28x58x362 mm

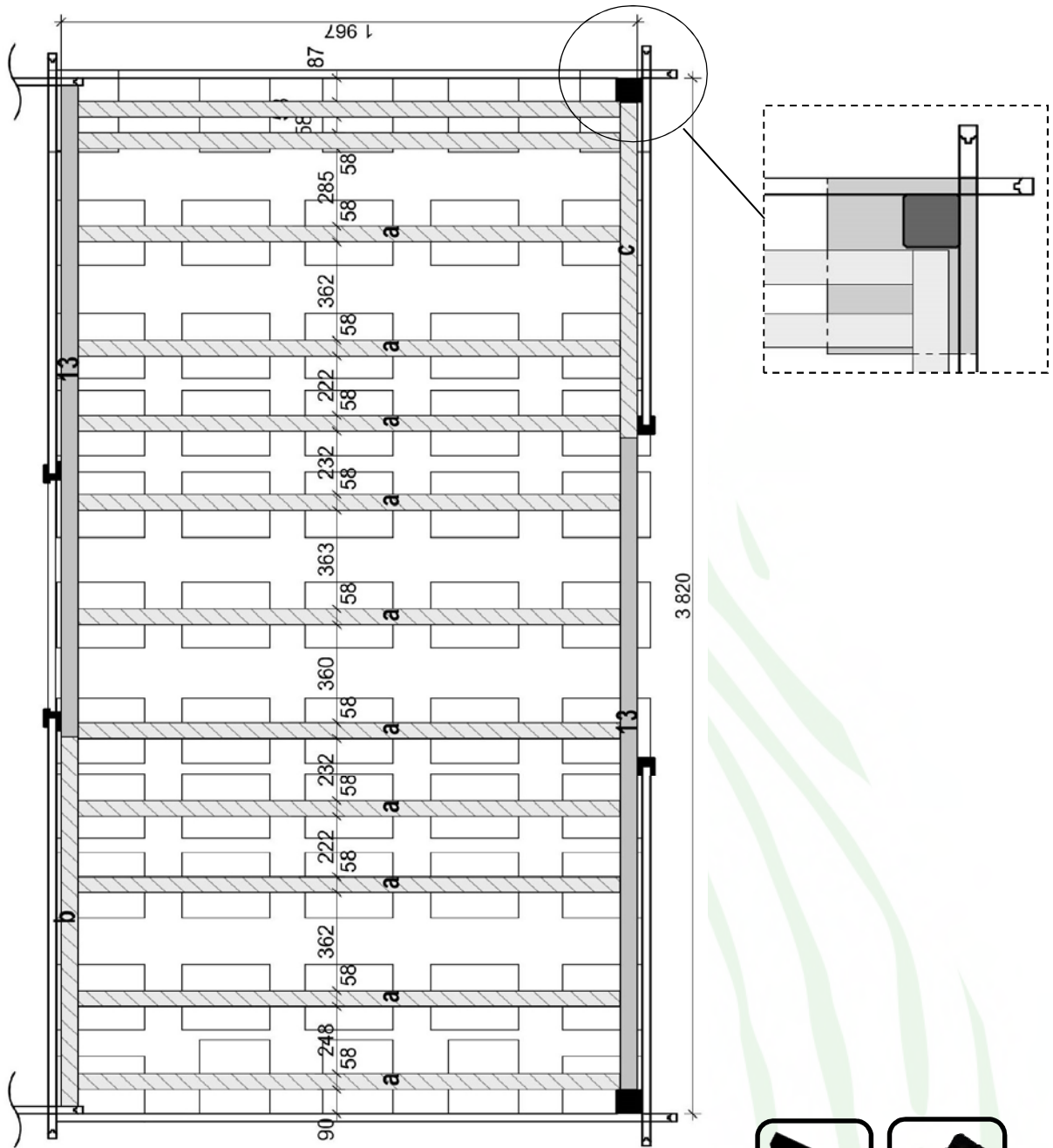

1x **c** Legar 28x58x238 mm

DOM18-1 400x200cm 28mm

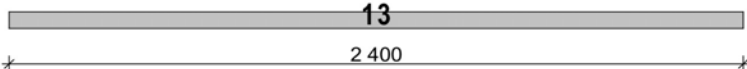

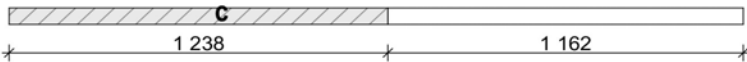
- 2x **13** Legar 28x58x**2400** mm 
- 12x **a** Legar 28x58x**1850** mm 
- 1x **b** Legar 28x58x**1360** mm 
- 1x **c** Legar 28x58x**1238** mm 

DOM393-1 400x300cm 28mm

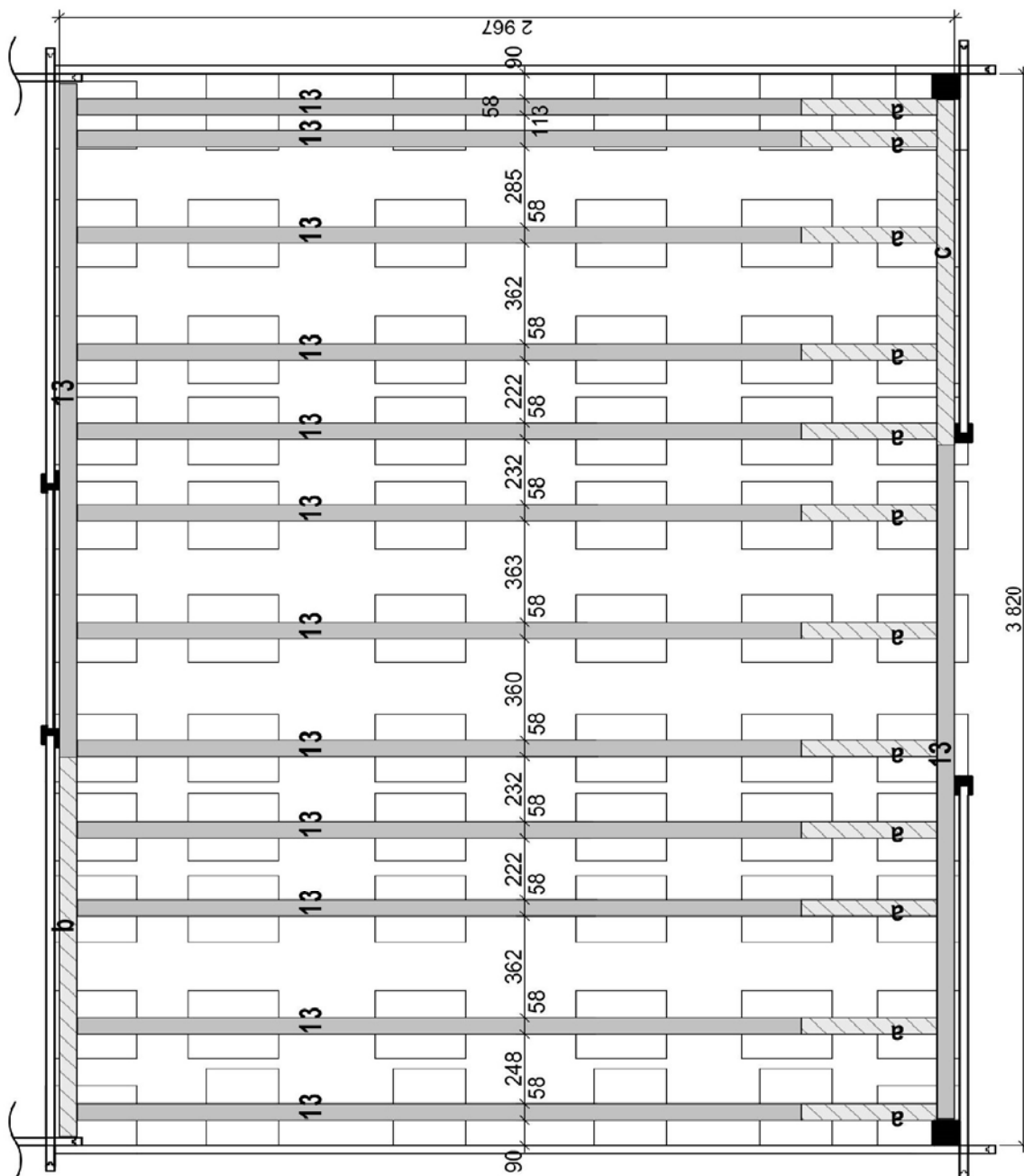

14x **13** Legar 28x58x2400 mm

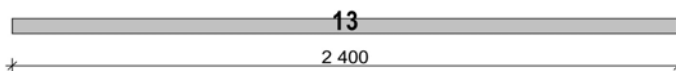

12x **a** Legar 28x58x450 mm

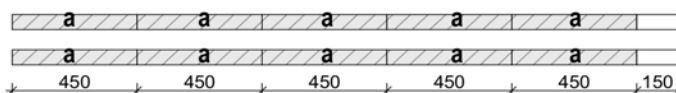

1x **b** Legar 28x58x1350 mm

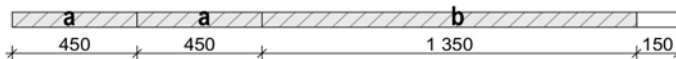

1x **c** Legar 28x58x1230 mm

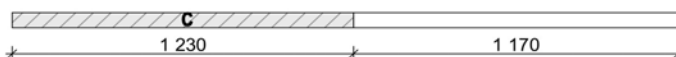

5

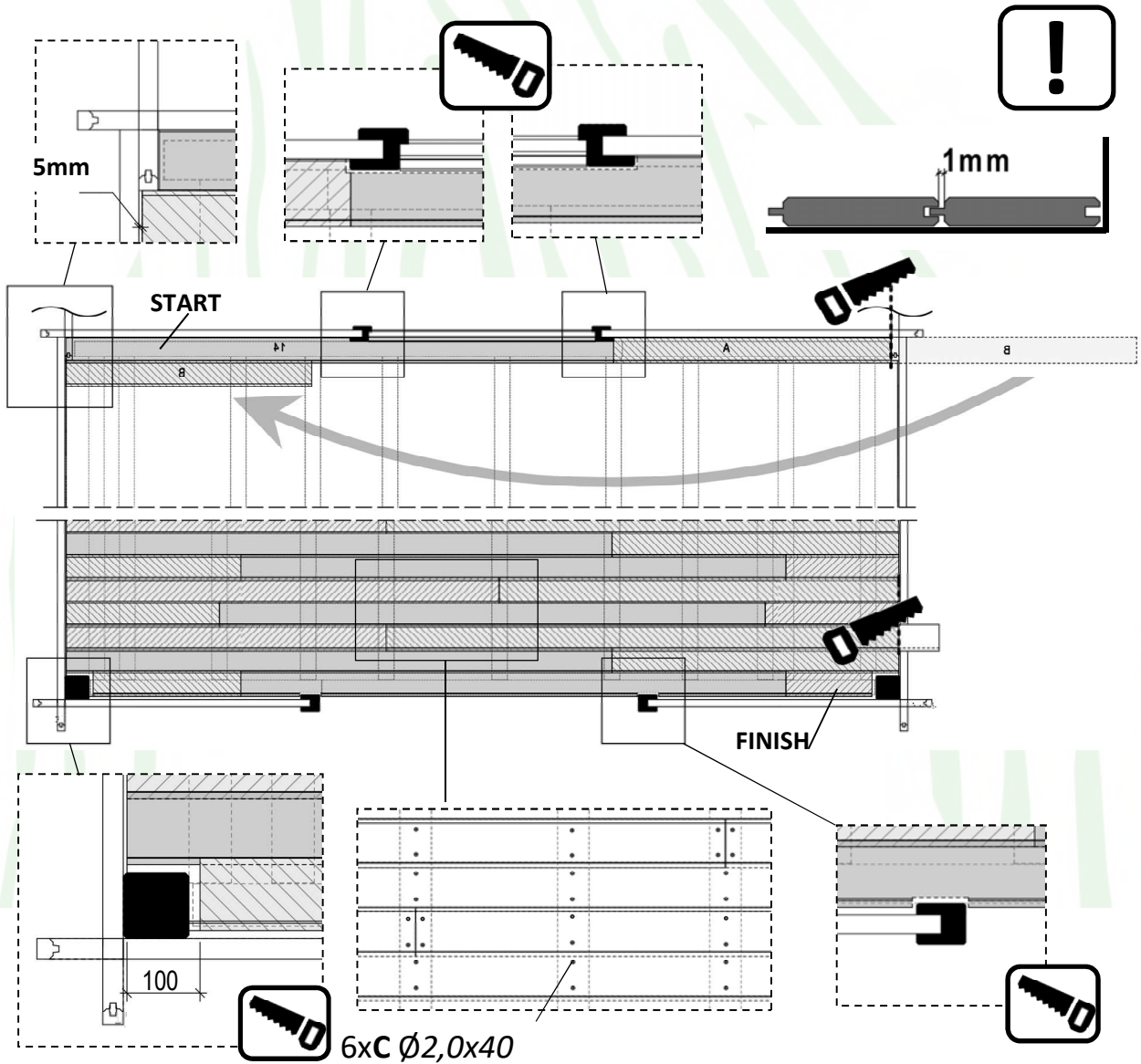
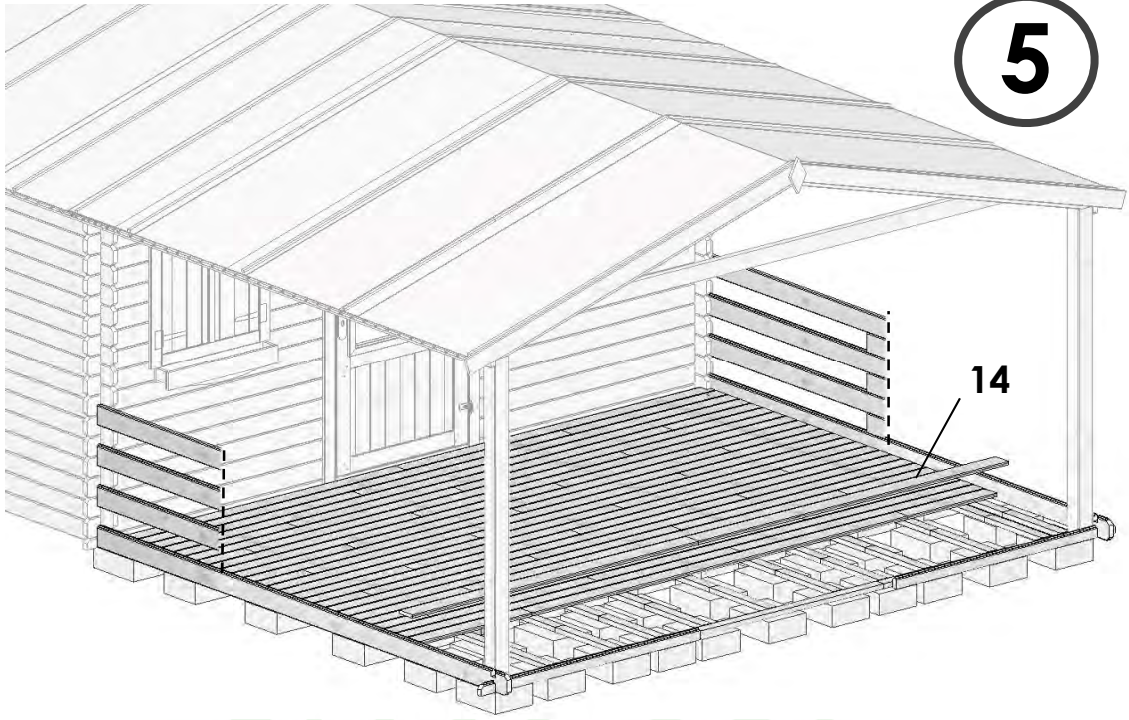

DOM142-1 300x200cm 28mm

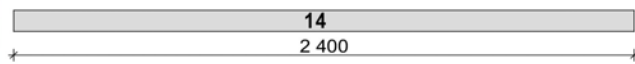
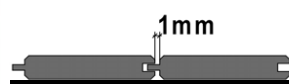
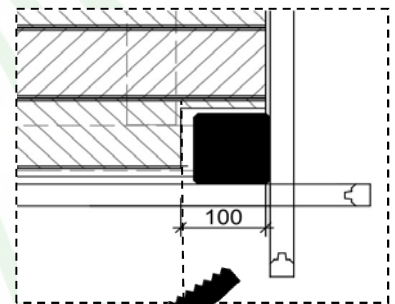
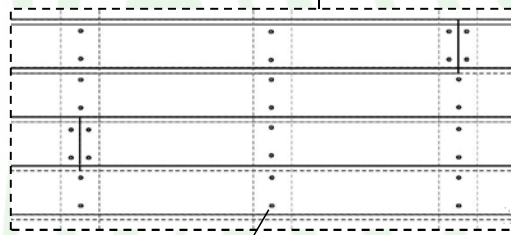
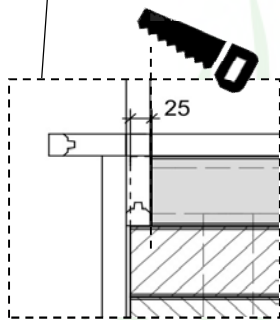
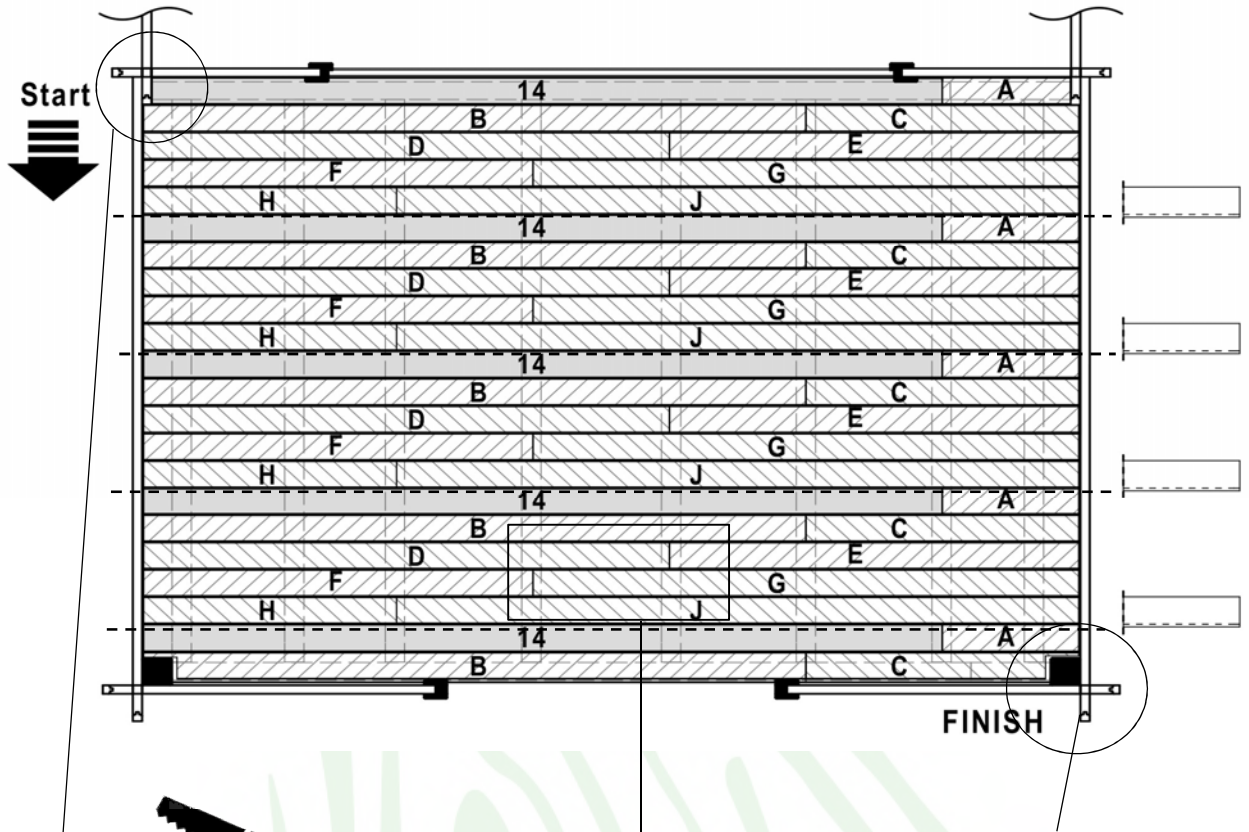

5x **14** Deska podłogi 19x99x2400 mm



5x **A** 19x99x410 mm
5x **B** 19x99x1990 mm



5x **C** 19x99x820 mm
4x **D** 19x99x1580 mm



4x **E** 19x99x1230 mm
4x **F** 19x99x1170 mm



4x **G** 19x99x1640 mm
4x **H** 19x99x760 mm

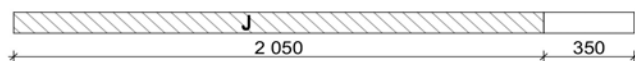

4x **J** 19x99x2050 mm

DOM395-1 300x300cm 28mm

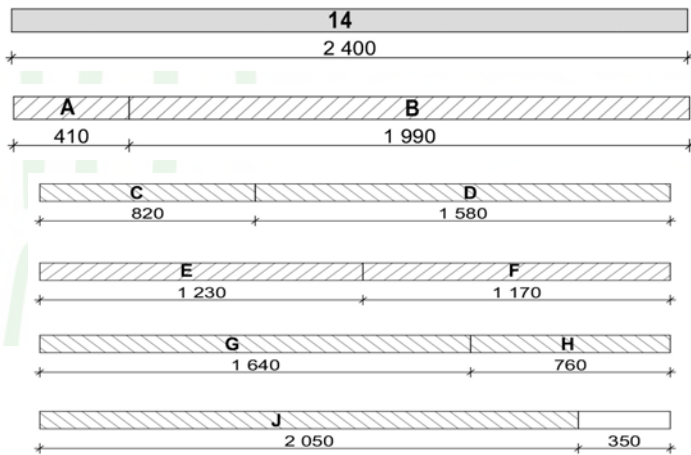
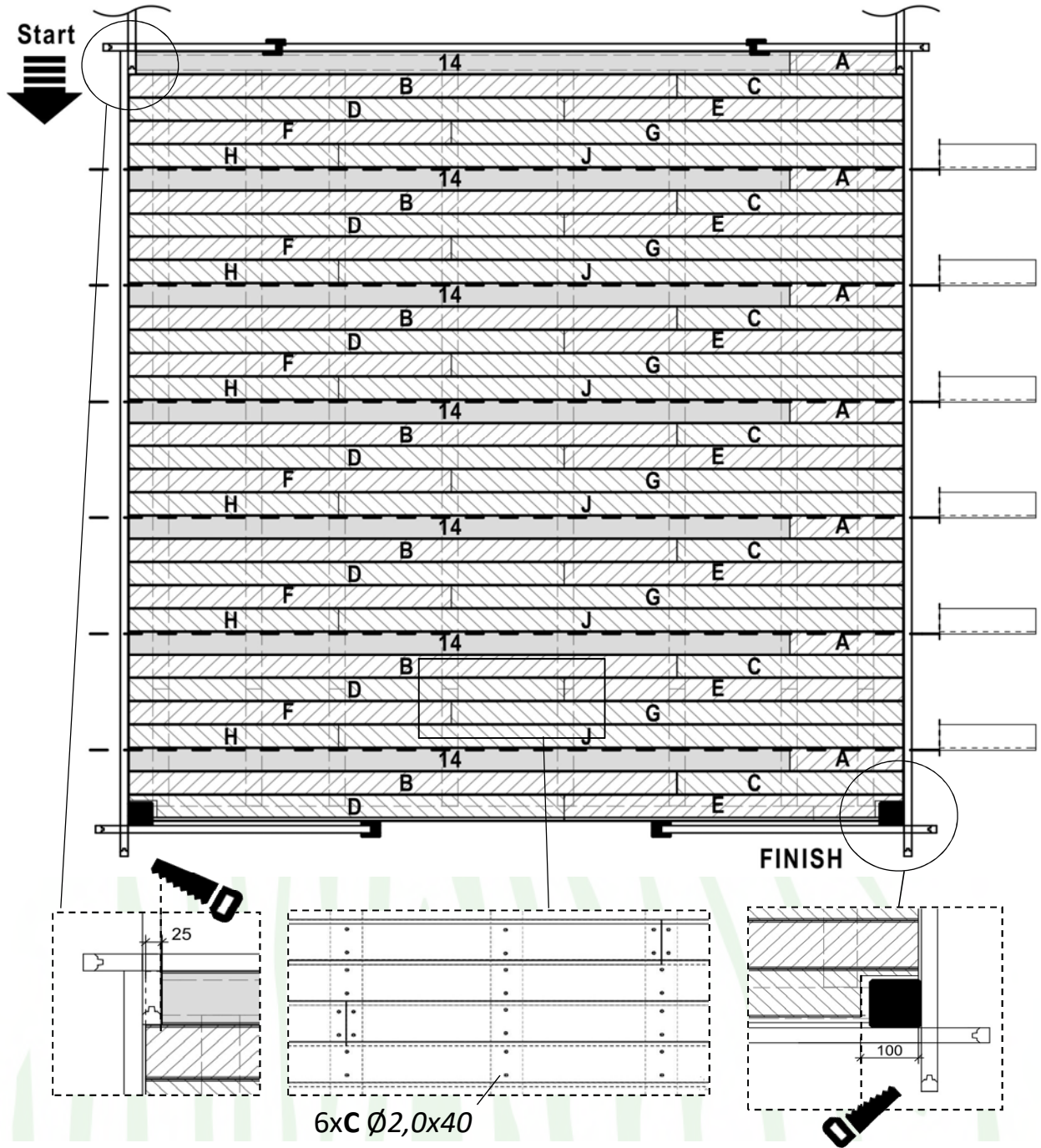

7x **14** Deska podłogi 19x99x2400 mm

7x **A** 19x99x410 mm

7x **B** 19x99x1990 mm

7x **C** 19x99x820 mm

7x **D** 19x99x1580 mm

7x **E** 19x99x1230 mm

6x **F** 19x99x1170 mm

6x **G** 19x99x1640 mm

6x **H** 19x99x760 mm

6x **J** 19x99x2050 mm

DOM18-1 400x200cm 28mm

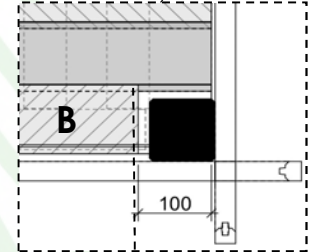
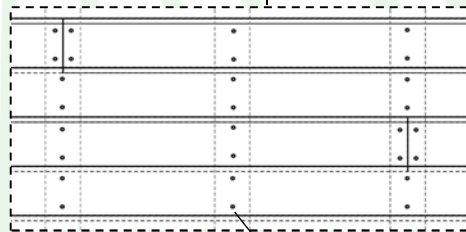
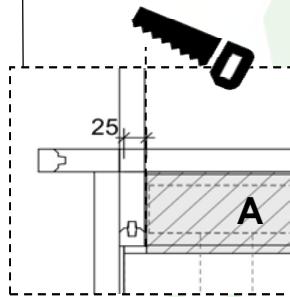
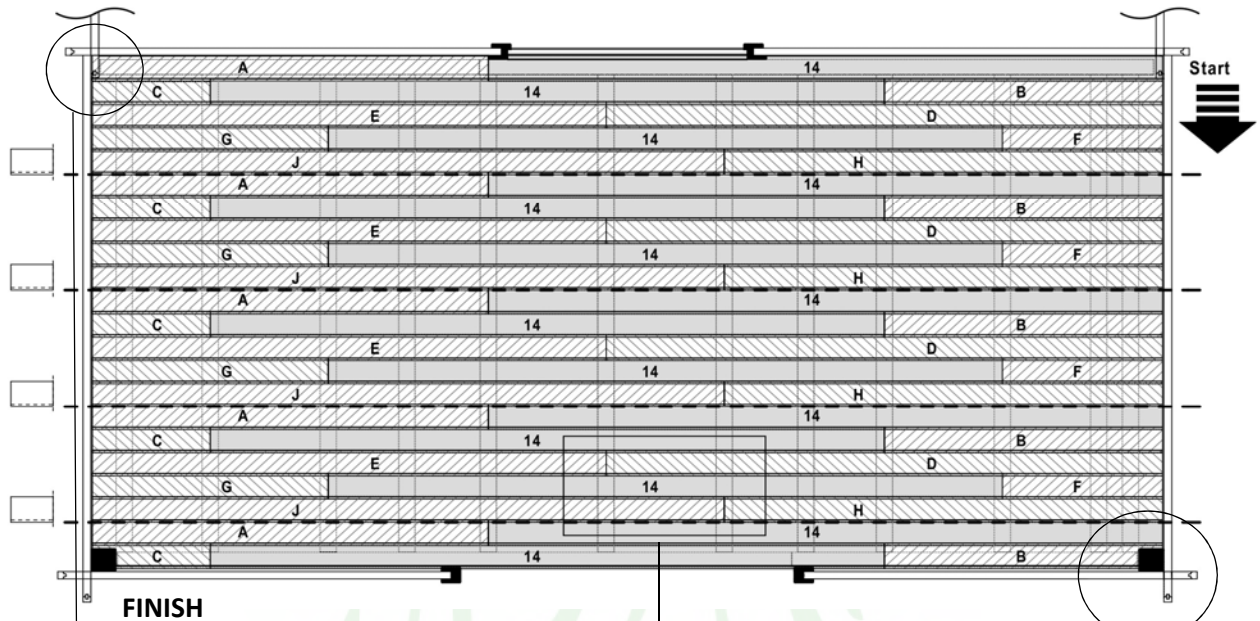

C Ø2,0x40

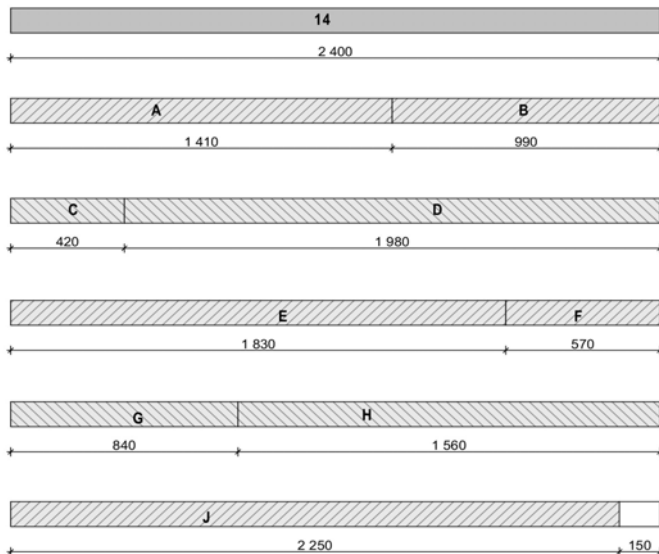
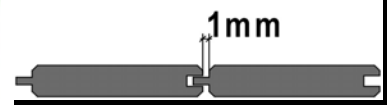

14x 14 Deska podłogi 19x99x2400 mm

5x **A** 19x99x1410 mm

5x **B** 19x99x990 mm

5x **C** 19x99x420 mm

5x **D** 19x99x1980 mm

5x **E** 19x99x1830 mm

5x **F** 19x99x570 mm

4x **G** 19x99x840 mm

4x **H** 19x99x1560 mm

4x **J** 19x99x2250 mm

DOM393-1 400x300cm 28mm

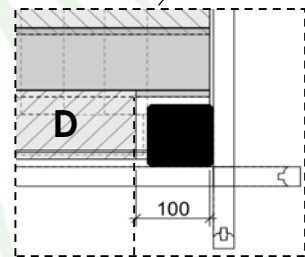
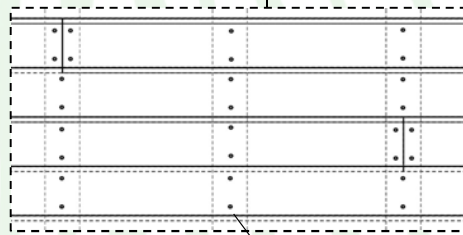
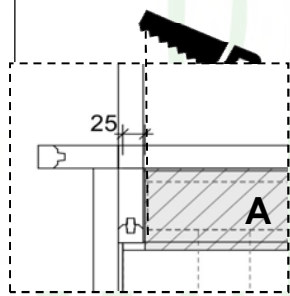
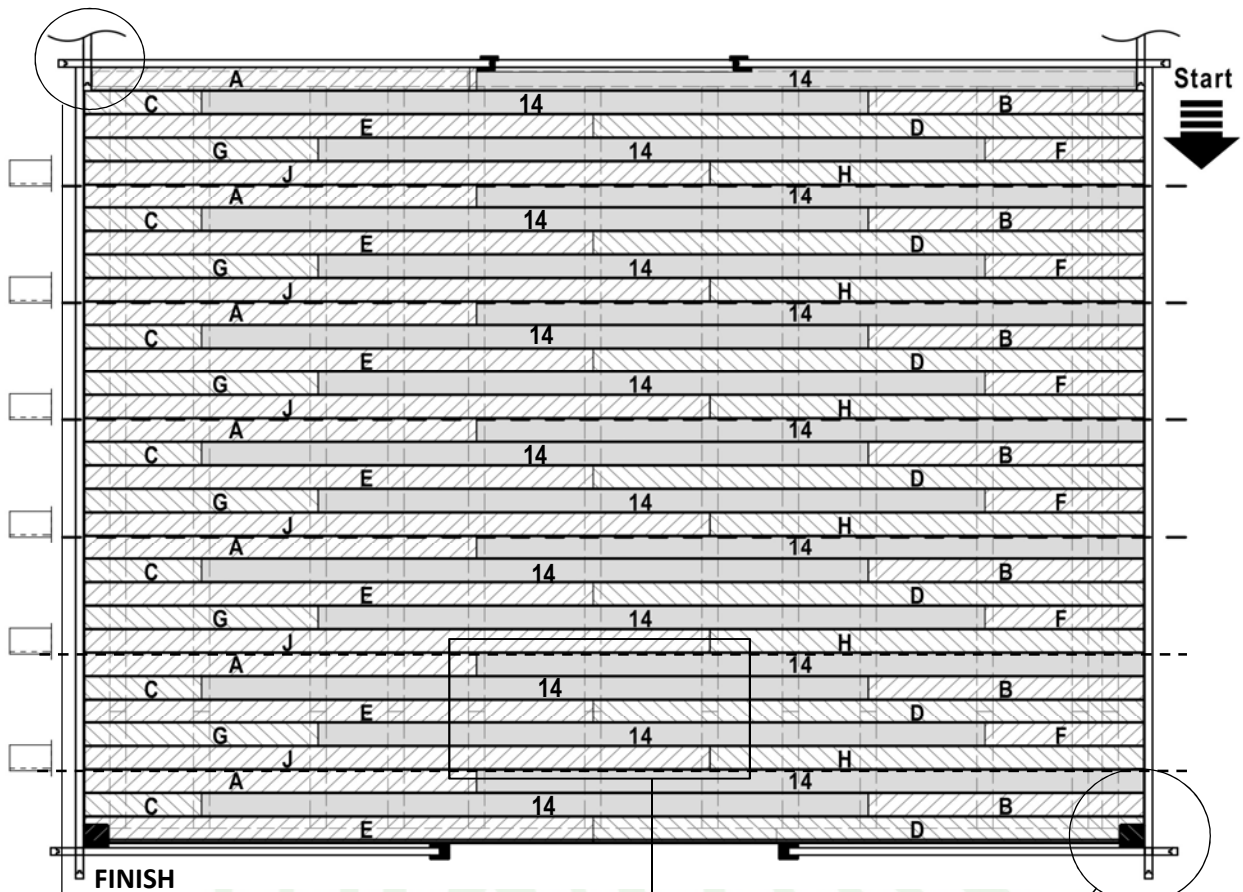

C Ø2,0x40

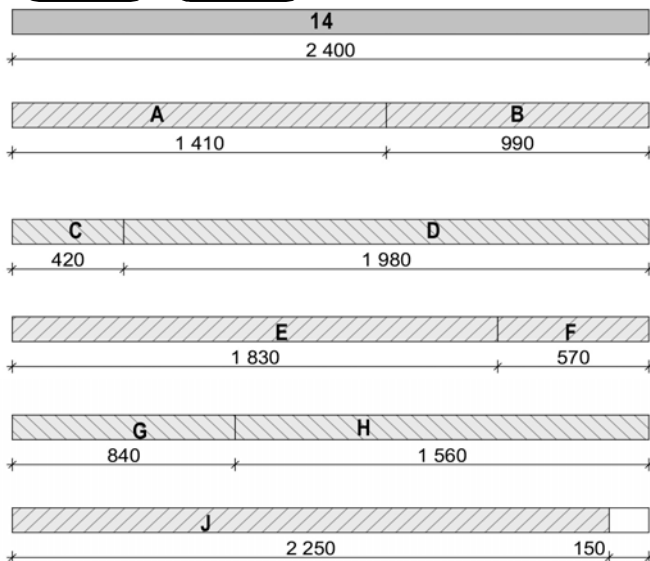

20x 14 Deska podłogi 19x99x2400 mm

7x **A** 19x99x1410 mm

7x **B** 19x99x990 mm

7x **C** 19x99x420 mm

7x **D** 19x99x1980 mm

7x **E** 19x99x1830 mm

6x **F** 19x99x570 mm

6x **G** 19x99x840 mm

6x **H** 19x99x1560 mm

6x **J** 19x99x2250 mm

6

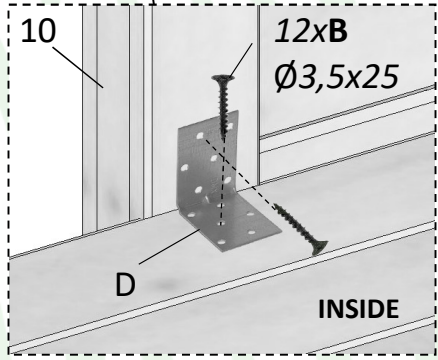
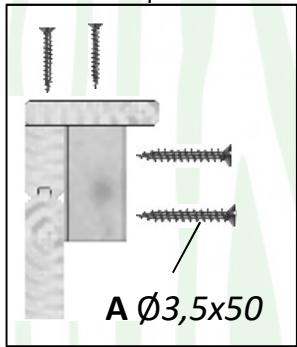
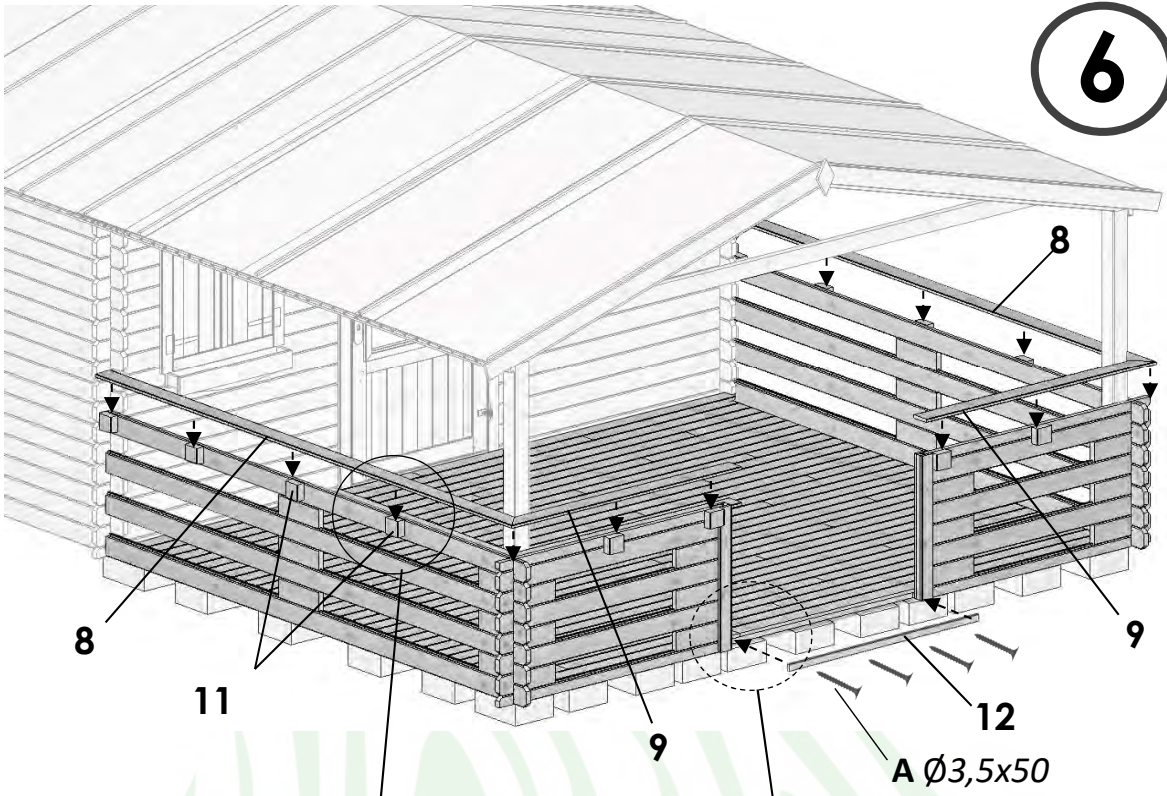

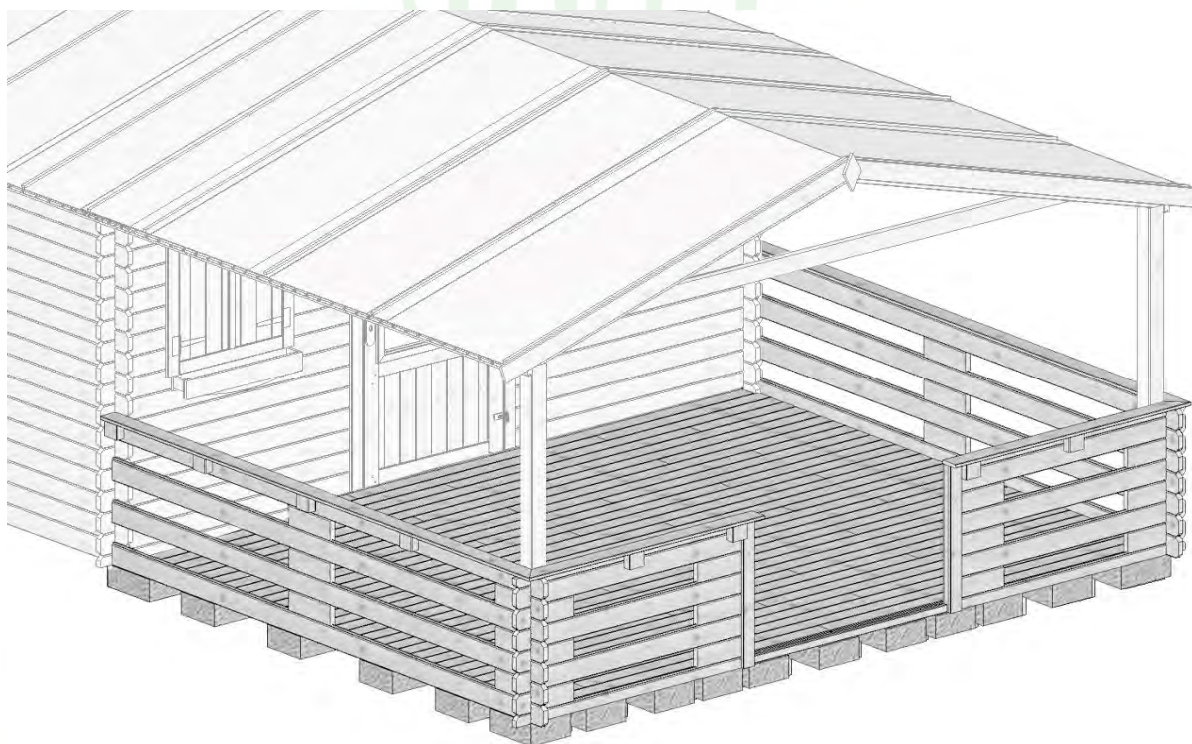

MONTAŻ PODŁOGA 3m²

BI

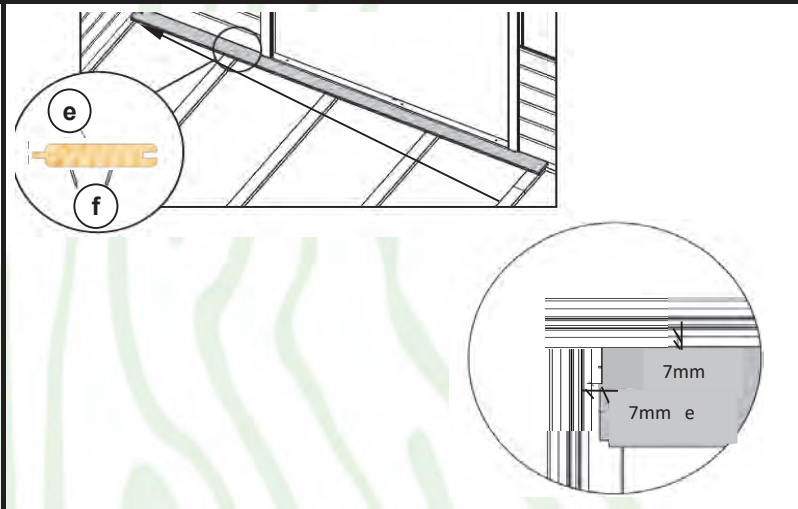
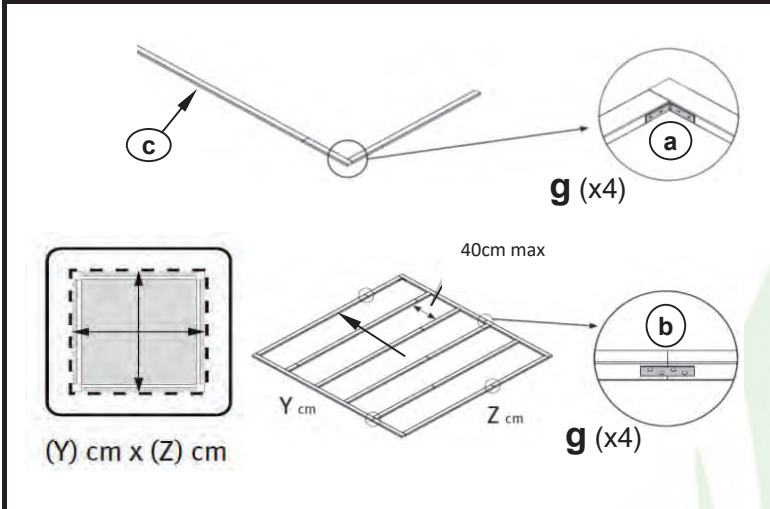

a		x2
b		x3
c		x4
d		x2
e		x14
f		x200
g		x20

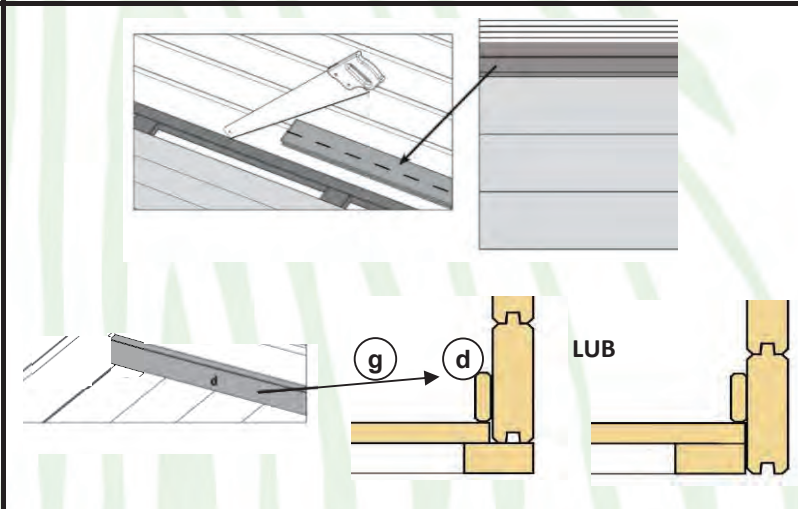
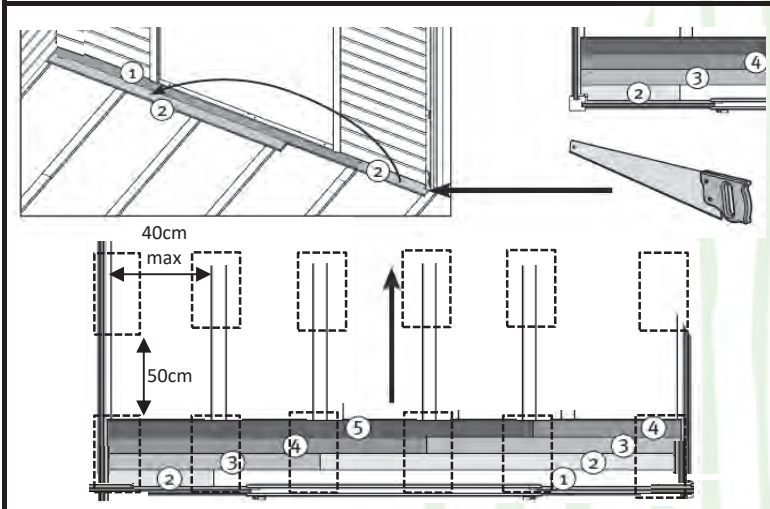











UŁOŻENIE BLOCZKÓW BETONOWYCH POD KONSTRUKCJĄ PODŁOGI/DOMKU

--	--	--	--	--

No **109443**

PODŁOGA - 19 mm 3m²

LP	NAZWA - ELEMENTY	[mm]	[mm]	[m]	[szt.]
1	 deska podłogi pióro wpust dachowa 	19	99	2,4	14
2	 listwa przypodłogowa (profil faszolki) 	13	45	2,4	2
3	 legar podłogi - IMPREGNOWANY 	28	58	2,4	4
LP	OKUCIA PODŁOGI	[mm]		[szt.]	
1	gwoździe 	2,0x40		200	
2	plaskownik łącznik z 4 otworami 	12x100		3	
3	kątownik 	12x65x65		2	
4	wkręt do drewna 	3,5x30		20	

DATA:

podpis osób pakujących

No **109443**