

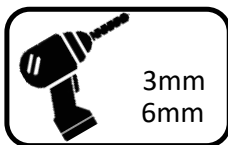

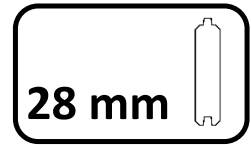















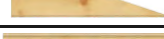

1.16x0.84m









h= 1.16 m

SZA14-1



# SZA14-1 116x84cm 28mm

nr	Element	Size (mm)			pcs	miss	damaged
		d	h	L			
1		28	121	1025	10		
2		28	113	1025	2		
3		28	121	1200	5		
4		28	113	1200	2		
5		28	65	1200	1		
6		28	121	655	18		
7		28	121	110	14		
8		28	113	655	2		
9		28	121	775	6		
10		28	113	775	1		
11		27	47	485	2		
12		27	47	780	3		
13		13	45	1125	4		
14		13	45	1020	4		
15		13	45	810	3		
16		13	45	330	1		
17		28	50	50	1		

nr	Element	Size (mm)	pcs	miss	damaged
A		40x100	4		
B		65mm	1		
C		4,0x80	48		
D		3,5x50	56		
E		3,5x35	34		
F		3,5x25	30		
G		M6	1		
H		ø6	1		
I		6,0x50	1		

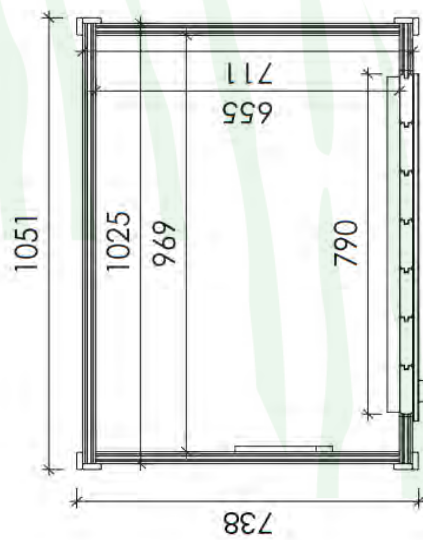
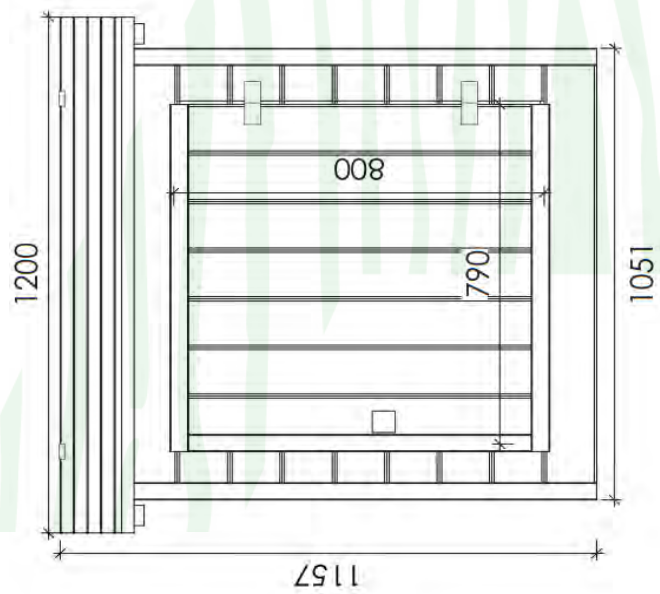
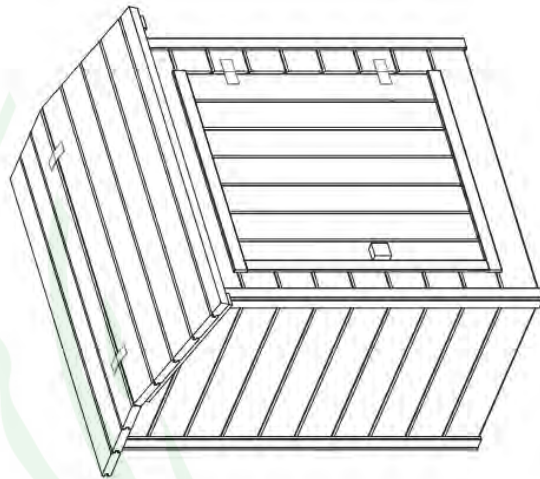
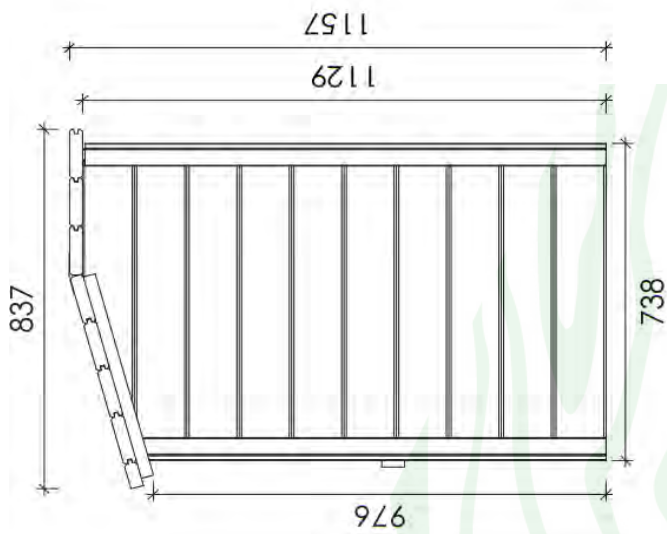

I

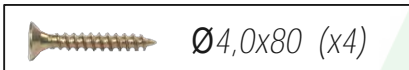
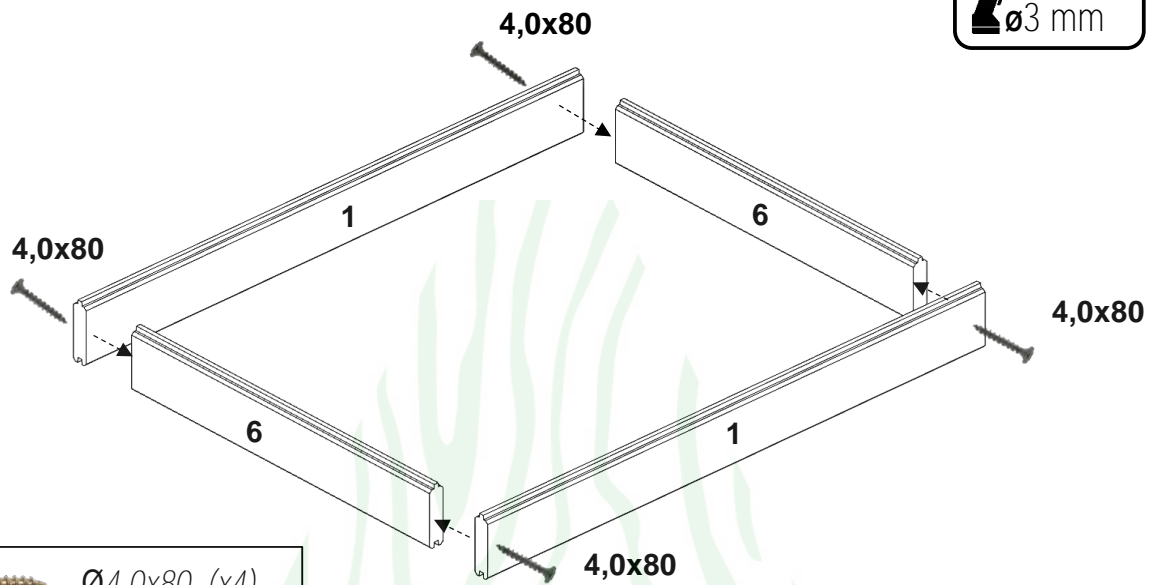

II

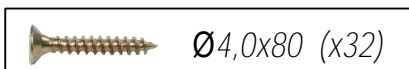
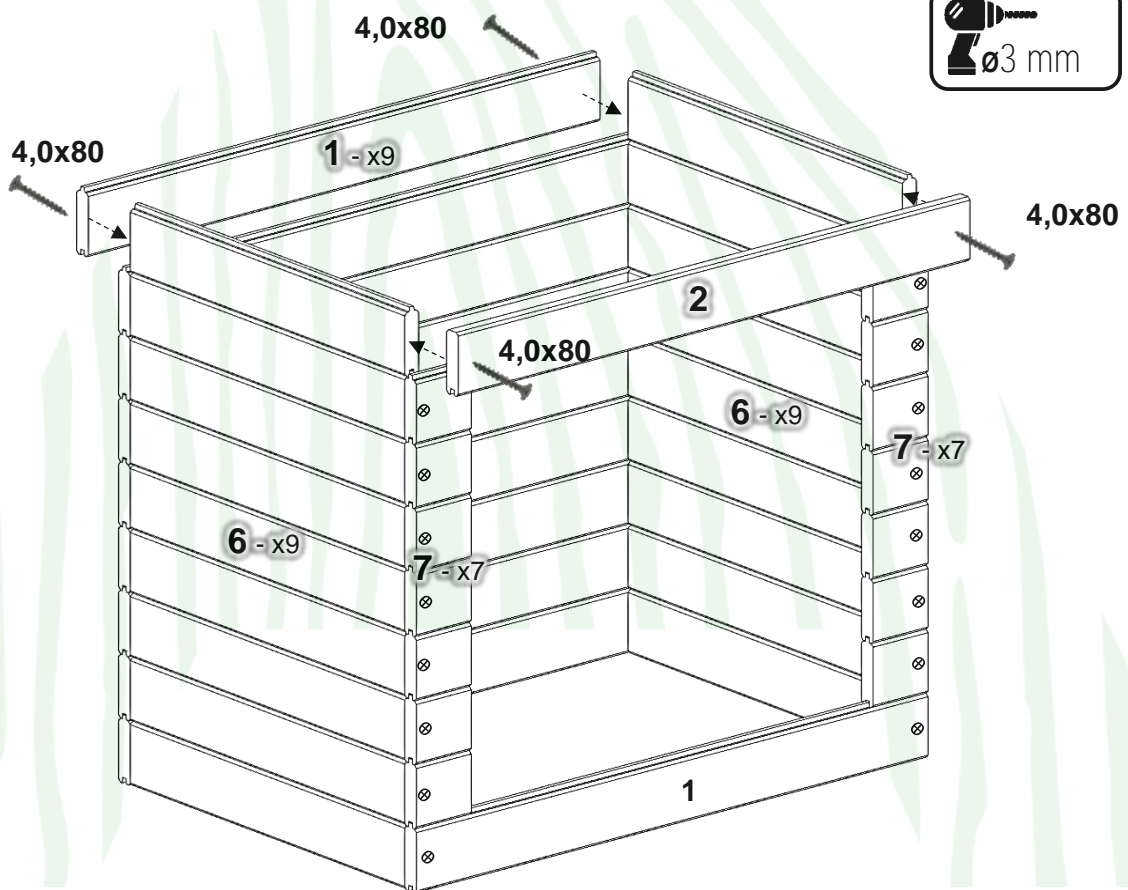

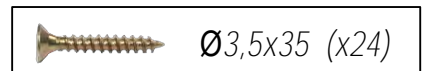
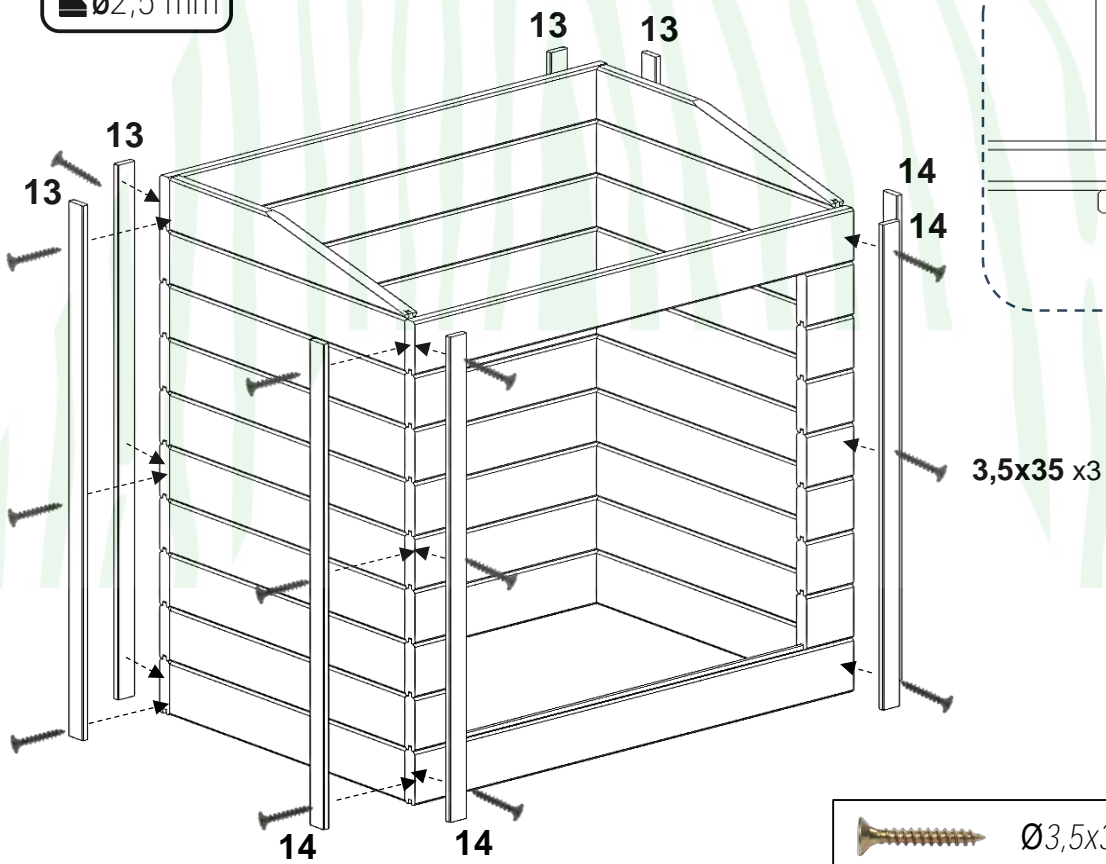
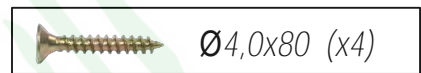
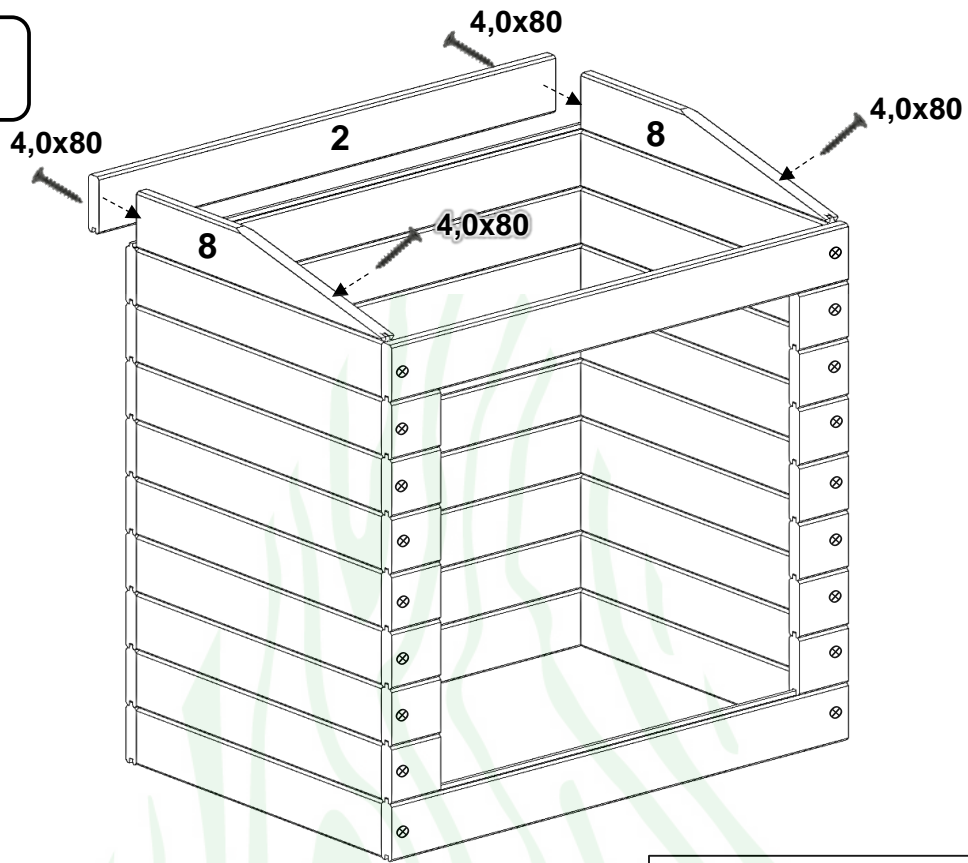

V

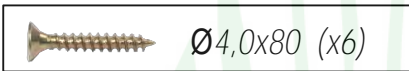
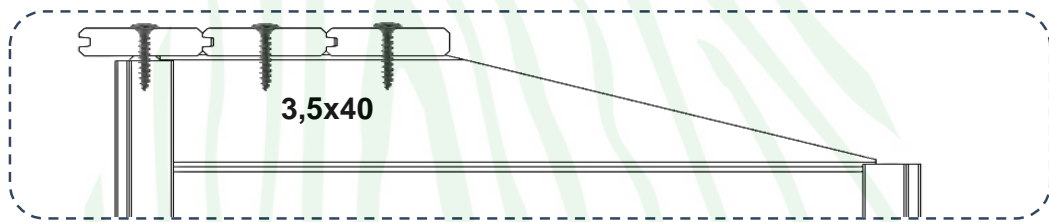
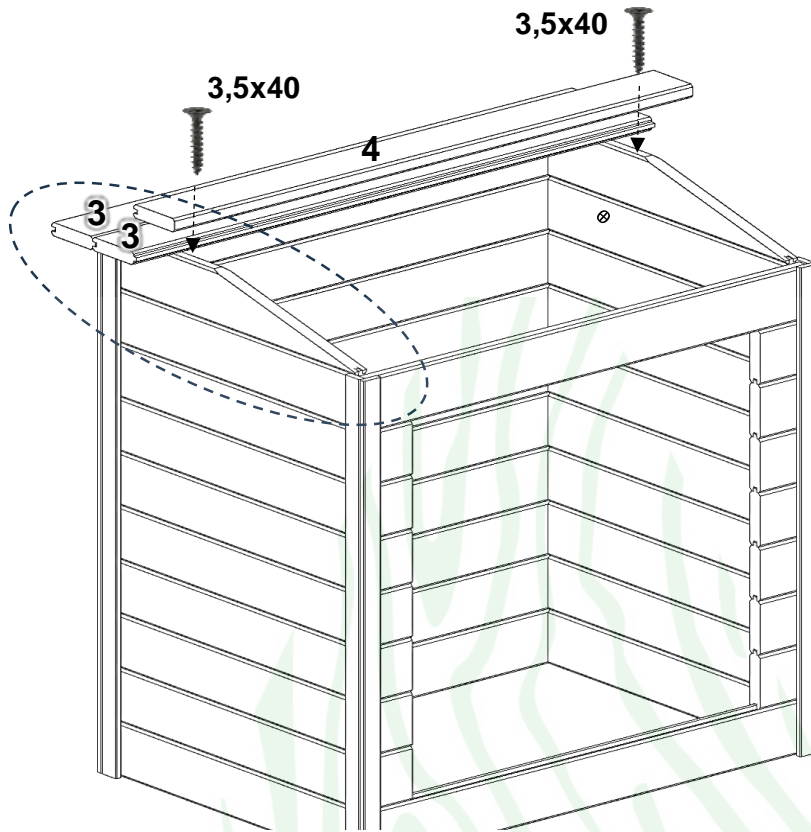

VI

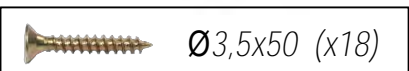
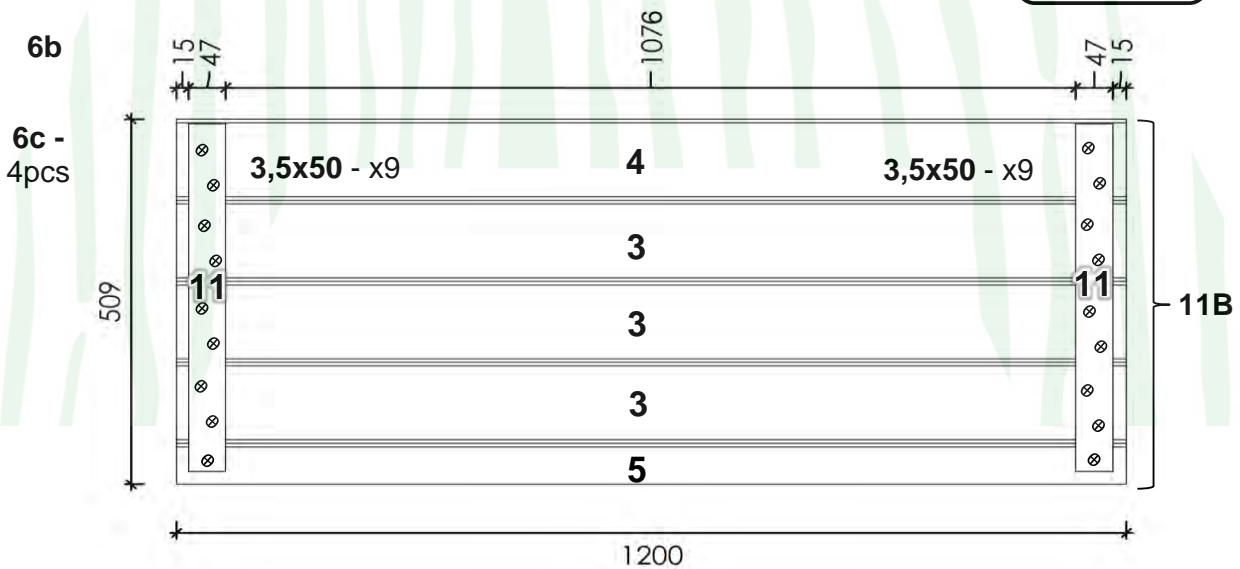

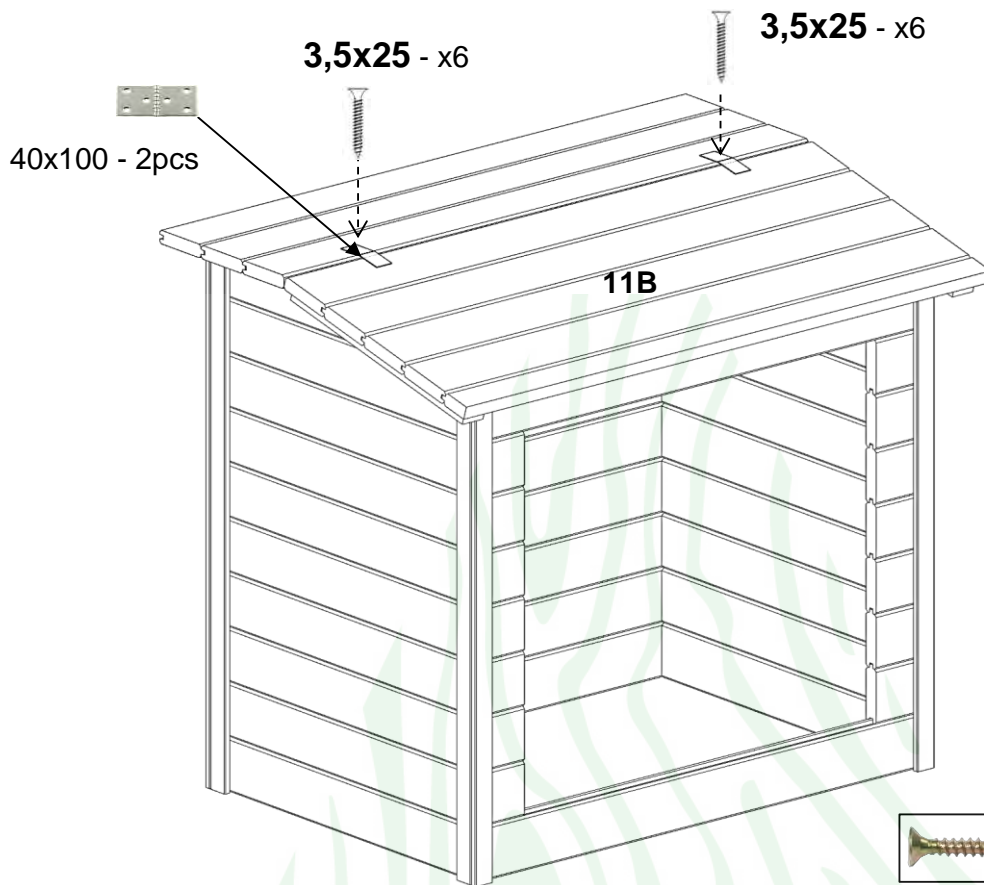

VII

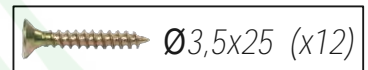

VIII

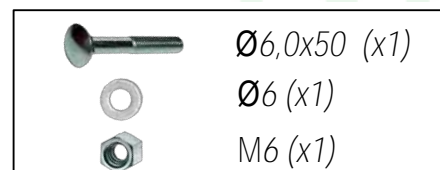
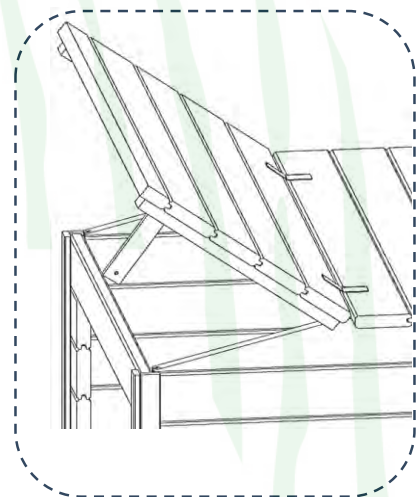
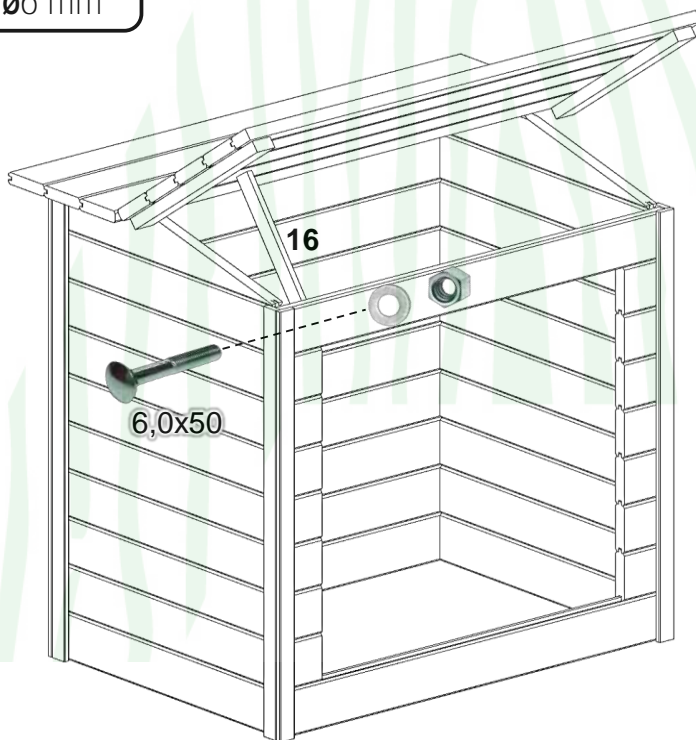

IX

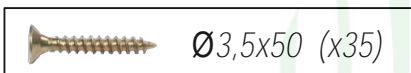
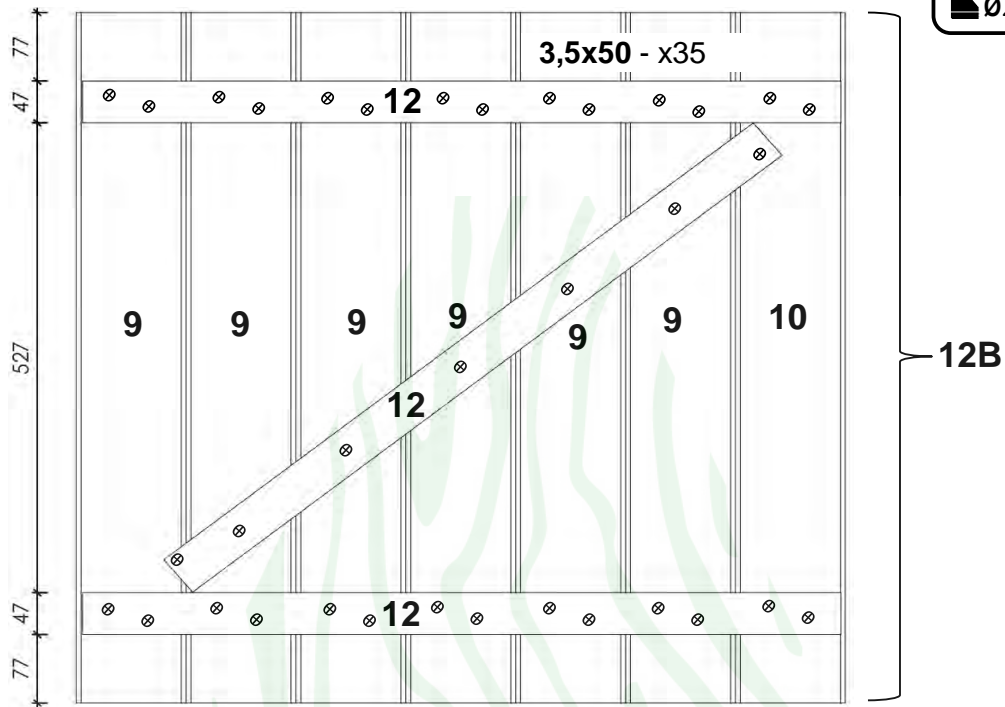

X

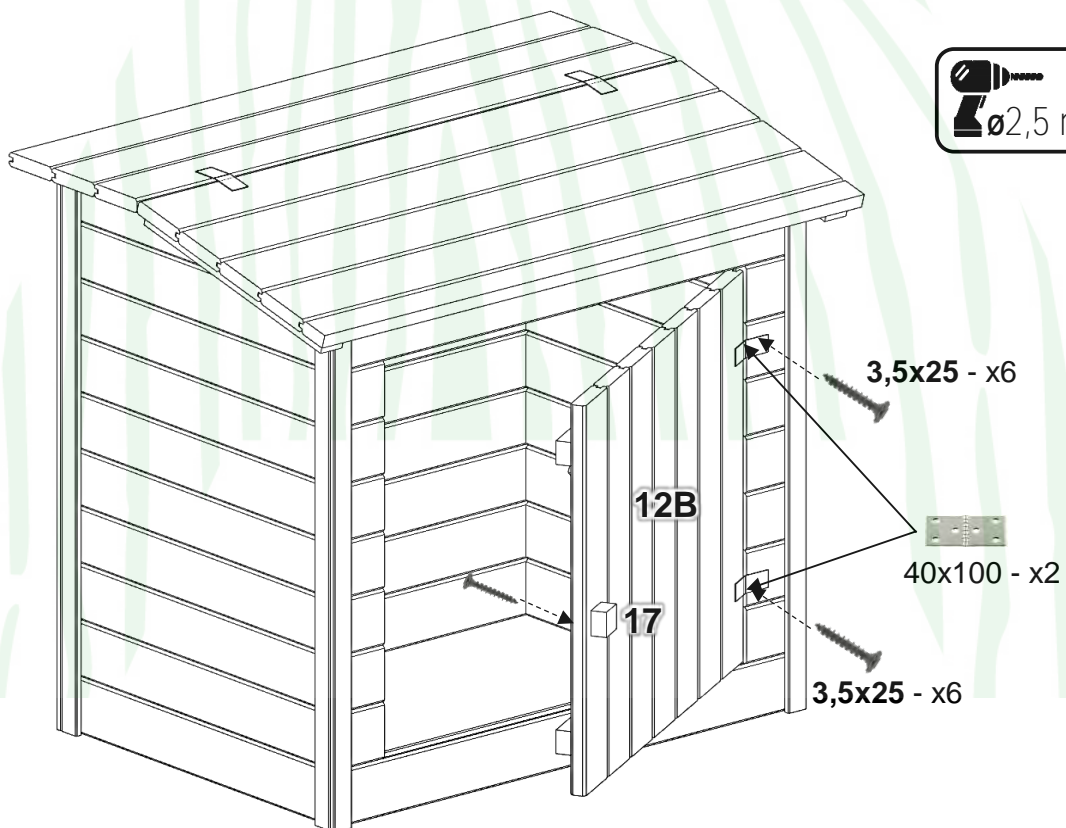



XI

